



TK

CD-N301

Network CD Player

使用说明书
사용 설명서

注意：在操作本机之前请阅读此部分。

- 1 要确保最好的性能，请仔细阅读此手册。请将它保存在安全的地方以备将来参考。
- 2 请将本声音系统安装在通风良好，凉爽并且干燥，干净的地方 - 应远离直射阳光，热源，振动，灰尘，潮湿和 / 或寒冷的地方。为了使通风良好，请在周围至少留出以下间隙。
顶部：10 cm
背面：10 cm
侧面：10 cm
- 3 请将本机远离其它电子设备、马达或变压器以避免嗡嗡声。
- 4 请勿使本机经受过从冷到热的突然温度改变，勿将本机放置于高湿度的环境中（例如有加湿器的房间）以防止本机内部发生结露，否则可能导致触电、火灾，损坏本机，和 / 或人体伤害。
- 5 请避免在外部物体可能落入本机的地方或本机可能遭遇液体滴落或飞溅的地方安装本机。在本机的顶部，请勿放置：
 - 其它组件机，因为它们可能对本机表面造成损坏和 / 或导致变色。
 - 燃烧物体（例如蜡烛），因为它们可能导致火灾，对本机造成损害和 / 或造成人体伤害。
 - 内部装有液体的容器，因为它们可能会摔落并且液体可能引起用户触电损坏本机。
- 6 为了不阻断热量散发，请勿使用报纸、桌布、窗帘等遮盖本机。如果本机内的温度升高，可能会引起火灾，损坏本机和 / 或导致人体伤害。
- 7 在所有的连接完成之前请勿将本机插头插入墙上插座。
- 8 请勿上下倒置操作本机。它可能过热，并极有可能导致损坏。
- 9 请勿在开关、旋钮和 / 或导线上用力。
- 10 当将电源线从墙上插座断开时，请抓住插头；请勿拖拉导线。
- 11 请勿使用化学溶剂清洁本机；这可能损坏机壳涂层。请使用洁净的干布。
- 12 只能使用本机规定的电压。在本机上使用比规定值高的电压是危险的并可能导致火灾，损坏本机和 / 或造成人体伤害。Yamaha 将不对由于在本机上使用非规定电压而造成的任何损害负责。
- 13 为了避免雷击造成损坏，在雷电期间，将电源导线从墙壁上的电源插座拔下，也将天线从本机上拔下。
- 14 请勿尝试修改或修理本机。当需要任何维修时请联系专业 Yamaha 维修人员。不能以任何理由打开机壳。
- 15 当准备长时间（例如休假）不使用本机时，请将交流电源线从墙上插座断开。
- 16 对通常的操作错误，在断定本机出故障之前，请务必先阅读“故障排除”一节。
- 17 在搬动本机之前，请按  以将本机设置为待机模式，并将交流电源插头从墙上插座断开。
- 18 如果环境温度剧烈变化，就可能形成结露。从插座上拔下电源插头，将本机搁置一旁。
- 19 长时间使用本机后，本机可能变热。将电源关闭，将本机搁置冷却。
- 20 将本机靠近交流电源插座安装以便交流电源的接插。
- 21 电池不能置于高热环境，比如火或直射日光等。
 - 如果电池老化，遥控器的有效操作范围将显著缩小。如果发生这种情况，请尽快更换新电池。
 - 请将电池放在儿童无法拿到的地方。如果儿童将电池放入嘴里，则可能有危险。
 - 请勿混合使用新旧电池。
 - 请勿混合使用不同类型的电池（如碱性电池和锌锰电池）。请仔细查看电池包装，因为这些不同类型的电池可能拥有相同的形状和颜色。
 - 老化的电池可能会泄漏液体。如果电池已泄漏，应立即进行处理。避免接触泄漏的材料或粘到衣物上等。全面清理电池盒，然后再安装新电池。
 - 如果计划在很长时间内不使用本机，请从本机取出电池。否则电池将老化，从而可能因电池液体泄漏而导致本机损坏。
 - 请勿将电池与普通家庭垃圾一起丢弃。请按当地的法律法规正确处理电池。
- 22 来自耳塞式耳机和双耳式耳机的额外声压也许会损害听力。

只要本机连接在墙壁的交流电源插座上，即使按下  按钮后本机自身被关闭，本机也没有从交流电源断开。这种状态被称为待机模式。在此状态下，本机消耗很小一部分电力。

警告

要减少火灾或触电的危险，请勿将本机暴露于雨中或湿气中。

目录

准备

本机功能	2
本机可以播放的音源	2
可控制本机的设备	3
在移动设备上操作	3
随机附件	4
遥控器准备	4
控制和功能	5
前面板	5
遥控器	6
后面板	8
前面板显示屏	8
连接	9
连接至放大器	9
连接至网络 (PC/NAS/Internet 连接)	10
打开本机	11

操作

设置网络设备	12
共享 PC 上存储的音乐文件	13
播放 CD	14
播放 CD	14
使用 A-B 重复播放	16
使用编程播放模式	16
播放 PC/NAS 上的音乐文件	17
通过主机或遥控器操作	17
播放 INTERNET 电台	19
播放 AirPlay	21
播放 iPod	21
播放 iTunes	21
清除 AirPlay	21
设置菜单	22
设置菜单操作	22
设置菜单项目	23
高级设置菜单	23
更新固件	24

其他

常见问题	25
故障排除	26
前面板显示屏消息	29
附加信息	30
可以播放的光盘和文件格式	31
可以播放的媒体和设备	31
可以播放的光盘和文件格式	32
规格	33
(本手册末页)	
有关第三方软件授权许可的信息	i

准备

操作

其他

关于本说明书

- 注意事项包含有关安全和操作说明的重要信息。📢 包含有关操作的提示信息。
- 本手册中所述的“iPod”也可指“iPhone”或“iPad”。

中文

本机功能

本机是一款网络 CD 播放机，您可以将本机连入家庭网络（DLNA）和同网音频系统，播放存储在媒体服务器（PC 或 NAS）上的音乐文件、Internet 电台中的音频内容、CD、AirPlay 设备（iPod/iTunes）。



有关 DLNA 或 NAS 的详情，请参阅“附加信息”（☞ 第 30 页）。

本机可以播放的音源

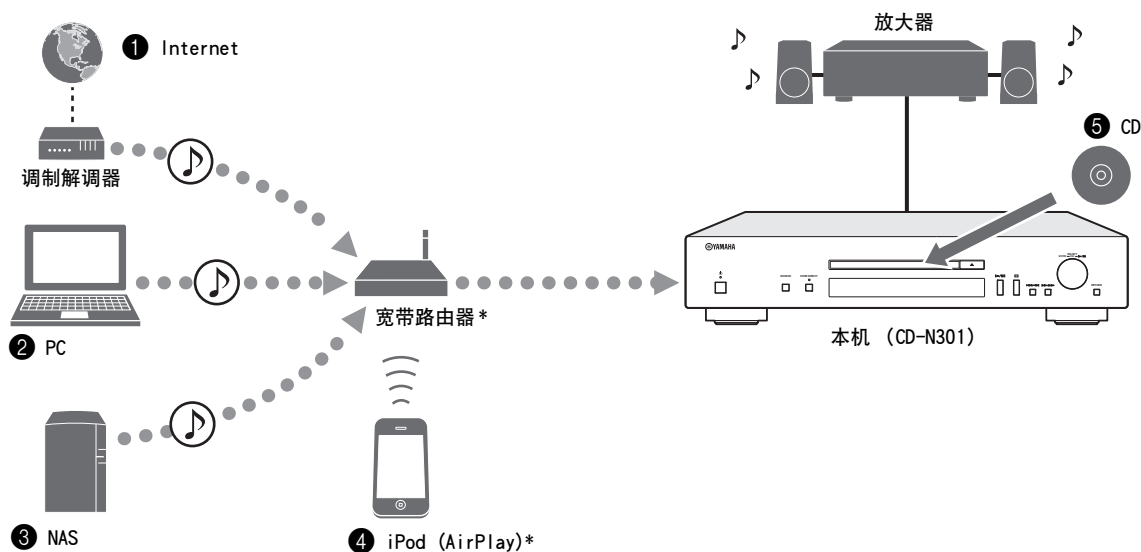

* 当您使用 iPod/Android 时，您需要拥有市售的 Wi-Fi 宽带路由器。

- ① 播放 Internet 广播（☞ 第 19 页）
- ② 播放存放在您计算机上的音乐文件（☞ 第 12 页，17）
- ③ 播放存放在您 NAS 上的音乐文件（☞ 第 12 页，17）
- ④ 使用 AirPlay 播放 iPod（☞ 第 21 页）
- ⑤ 播放 CD（☞ 第 14 页）



有关连接设备的详情，请查看“连接”（☞ 第 9 页）。

可控制本机的设备

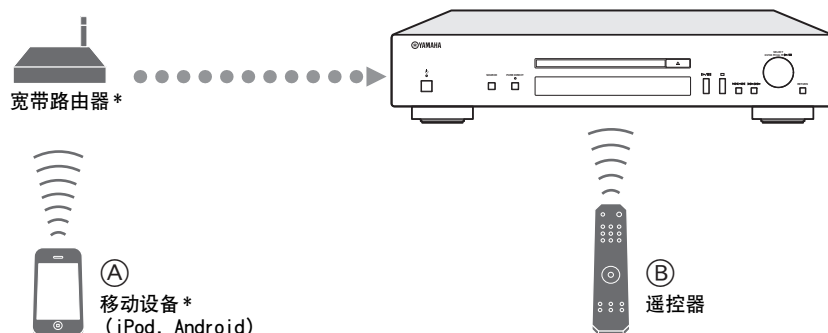

* 当您使用移动设备时，您需要拥有市售的 Wi-Fi 宽带路由器。

- Ⓐ 使用移动设备控制本机（☞ 第 3 页，12）
- Ⓑ 使用遥控器控制本机（☞ 第 6 页，14，17，19，22）

在移动设备上操作

一旦您在移动设备上安装了应用程序“NETWORK PLAYER CONTROLLER”之后，您可以使用移动设备操作本机。

功能

- 开关机或其他基本操作
- 更改音乐源
- 选择、播放和停止播放歌曲
- 播放装置中存储的歌曲

有关卸载应用程序或最新信息，请访问 App Store 或 Google Play，搜索“NETWORK PLAYER CONTROLLER”。

随机附件

请检查您收到了下列所有的物品。

遥控器

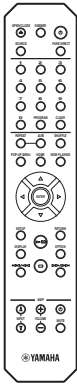

RCA 立体声电缆

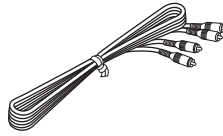

电源线

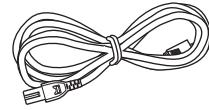

2 节电池 (AA, R6, UM-3)

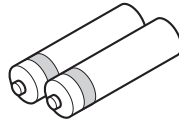

用户手册



遥控器准备

■ 安装电池

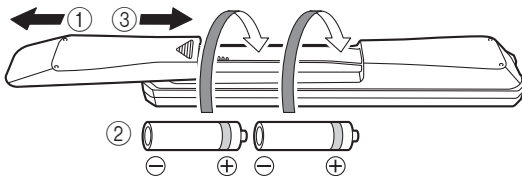

注意

- 如果遥控器的操作范围变窄，请更换所有电池。
- 安装新电池之前，请擦净电池舱。

■ 操作范围

操作时将遥控器直接对准主机上的遥控传感器。

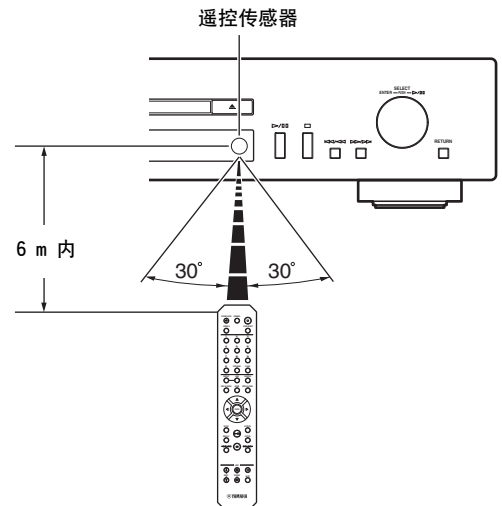

控制和功能

前面板

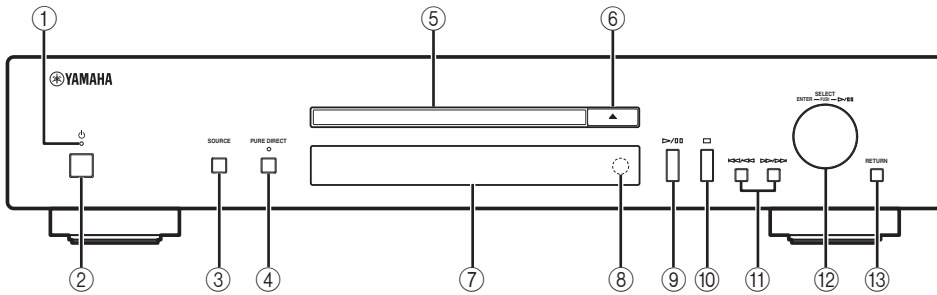

① 电源指示灯

- 点亮：
本机通电。
- 微暗点亮：
本机处于待机模式。
- 熄灭：
本机关机。



本机处于待机模式时，您可以从网络设备（网络待机）控制电源。若要启用网络待机功能，请在设置菜单中将“System Config”→“Network Standby”设置为“On”（[第 22 页](#)）。

② 电源开关（[第 11 页](#)）

打开和关闭本机。



③ SOURCE（[第 14 页](#)、17、19）

选择音源。每按一下将如下循环切换音源。
CD → Server → Net Radio → AirPlay → 返回至 CD

④ PURE DIRECT

打开或关闭 PURE DIRECT 模式。当 PURE DIRECT 模式打开时，将提高音频质量。

注意

当本机处于 PURE DIRECT 模式时，数字输出关闭。



当 PURE DIRECT 模式打开时，PURE DIRECT 指示灯亮起。

⑤ 光盘托盘

装入光盘。

⑥ ▲（打开 / 关闭）

打开或关闭光盘托盘。

⑦ 前面板显示屏

显示菜单项目、播放信息等



有关可播放消息的详情，请参阅“前面板显示屏消息”（[第 29 页](#)）。

⑧ 遥控传感器（[第 4 页](#)）

接收来自遥控器的红外信号。

⑨ ▷/⏸（播放 / 暂停）

开始或暂停播放。

⑩ □（停止）

停止播放。

⑪ ⏮/⏪（跳过 / 向后搜索）

向后跳跃。播放期间按住按钮时，向后搜索音轨。

⏩/⏭（跳过 / 向前搜索）

向前跳跃。播放期间按住按钮时，向前搜索音轨。

⑫ SELECT/ENTER（控制拨盘）（[第 14 页](#)、17、19、23）

旋转以选择项目，按下以确认选择。

⑬ RETURN（[第 17 页](#)、19）

在前面板显示屏上显示高一級菜单。

遥控器

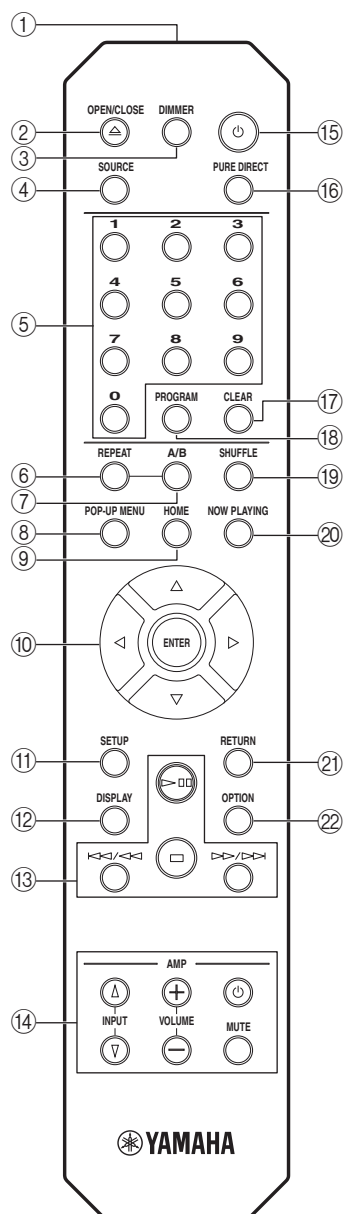

- ① 遥控器信号发射器
将红外信号发射到主机。
- ② OPEN/CLOSE
打开或关闭光盘托盘。
- ③ DIMMER
您可以按照三种亮度调节前面板显示屏的亮度：
亮、中亮或暗。每次按下按钮都可以更改亮度。
- ④ SOURCE (☞ 第 14 页、17、19)
选择音源。每按一下将如下循环切换音源。
CD → Server → Net Radio → AirPlay → 返回至 CD
- ⑤ 数字按钮 (☞ 第 15 页)
用于输入数字，例如 CD 轨道编号。
- ⑥ REPEAT (☞ 第 15 页、18)
切换重复播放模式。
- ⑦ A/B (☞ 第 16 页)
音频 CD 播放期间反复播放音轨的指定部分 (A-B 重复播放)。
- ⑧ POP-UP MENU
此按钮不适用于本机。
- ⑨ HOME (☞ 第 17 页、20)
选择 (浏览) 音乐文件、文件夹等项目时移动至
顶级。
- ⑩ ▲/▼/◀/▶ (光标按钮)/ENTER
使用光标按钮选择项目，按下 ENTER 以确认选择。
播放数据 CD、PC 或 NAS 上的音乐文件时可以更
更改播放文件夹或音乐文件。
- ⑪ SETUP (☞ 第 22 页)
在前面板显示屏上显示设置菜单。
- ⑫ DISPLAY (☞ 第 15 页、18、20)
切换前面板显示屏中显示的信息，例如播放信息。
- ⑬ 播放按钮 (☞ 第 15 页、18、20、21)
▶◻ (播放/暂停)
开始或暂停播放。
◻ (停止)
停止播放。
◀◀/▶▶ (向后跳跃/向后搜索)
向后跳跃。播放期间按住按钮时，向后搜索音轨。
▶▶/▶▶ (向前跳跃/向前搜索)
向前跳跃。播放期间按住按钮时，向后/向前搜
索音轨。

⑭ 放大器控制钮

控制 Yamaha 放大器的相应功能。

⏻ (电源)

打开和关闭放大器。

INPUT (Δ/▽)

切换输入源。

VOLUME (+/-)

调节音量。

MUTE

开启或关闭静音。

有关操作的详情，请参阅您的放大器的手册。



这些按钮可能对某些 Yamaha 放大器不起作用。

⑮ ⏻ (电源) (☞ 第 11 页)

将本机切换为打开或待机模式。

⑯ PURE DIRECT

打开或关闭 PURE DIRECT 模式。当 PURE DIRECT 模式打开时，将提高音频质量。

注意

本机处于 PURE DIRECT 模式时，数字输出和前面板显示将关闭。

⑰ CLEAR (☞ 第 16 页)

在编程编辑模式时删除音频 CD 中最后编程的音轨。退出编程模式停止播放时删除所有编程的轨道。

⑱ PROGRAM (☞ 第 16 页)

打开或关闭编程播放模式。在编程播放模式中，可以按编程的顺序播放音频 CD 中的音轨。

⑲ SHUFFLE (☞ 第 15 页、18)

切换随机播放模式。

⑳ NOW PLAYING (☞ 第 17 页、20)

选择 (浏览) 音乐文件、文件夹等内容时显示播放信息。

㉑ RETURN (☞ 第 17 页、20、22)

选择 (浏览) 音乐文件、文件夹等内容时向上移动一级别。

㉒ OPTION

此按钮不适用于本机。

后面板

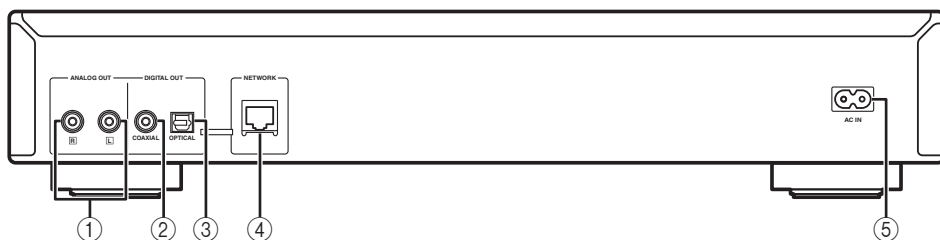

- ① **ANALOG OUT 端子** (☞ 第 9 页)
输出 L/R 模拟音频信号。使用 RCA 立体声电缆 (随机提供) 连接到放大器或音频系统。
- ② **DIGITAL OUT 端子 (COAXIAL)** (☞ 第 9 页)
输出数字音频信号。使用同轴数字音频电缆 (市售) 连接到放大器或音频系统。
- ③ **DIGITAL OUT 端子 (OPTICAL)** (☞ 第 9 页)
输出数字音频信号。使用光纤电缆 (市售) 连接到放大器或音频系统。
- ④ **NETWORK 端子** (☞ 第 10 页)
使用网线 (市售) 连接到网络。
- ⑤ **AC IN 套接字** (☞ 第 9 页)
使用电源线 (随机附带) 连接至 AC 插座时。

前面板显示屏

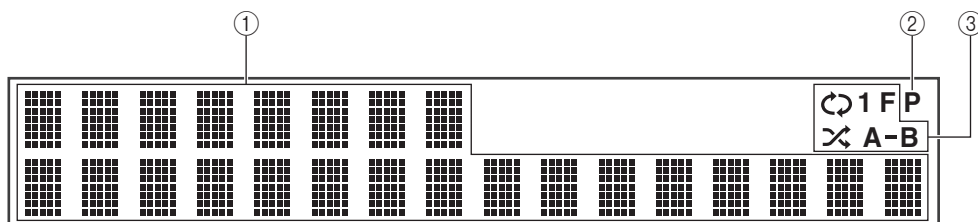

- ① **信息显示**
显示各种信息，例如音乐标题。
☞
有关所显示消息的更多信息，请参阅“前面板显示屏消息” (☞ 第 29 页)。
- ② **PROGRAM 指示灯**
当本机处于程序播放模式时亮起 (☞ 第 16 页)。
- ③ **REPEAT/SHUFFLE 指示灯** (☞ 第 14 页、17)
本机处于重放或随机播放模式时亮起。
重复播放
☞ : REPEAT ALL
☞1 : REPEAT ONE
☞F : REPEAT FOLDER
A-B : A-B REPEAT
随机播放
☞ : SHUFFLE ALL
☞F : SHUFFLE FOLDER

连接

本节介绍本机播放前所需的连接。

注意

- 在所有的连接完成之前请勿连接本机的电源线。
- 播放前无需将本机连接到放大器和扬声器。
- 本机可以输出高达 192 kHz/24 比特线性 PCM 信号的数字信号。
- 视所连接的设备和环境而定，可能无法正常播放。验证所连接播放音源设备的设定和规格。

连接至放大器

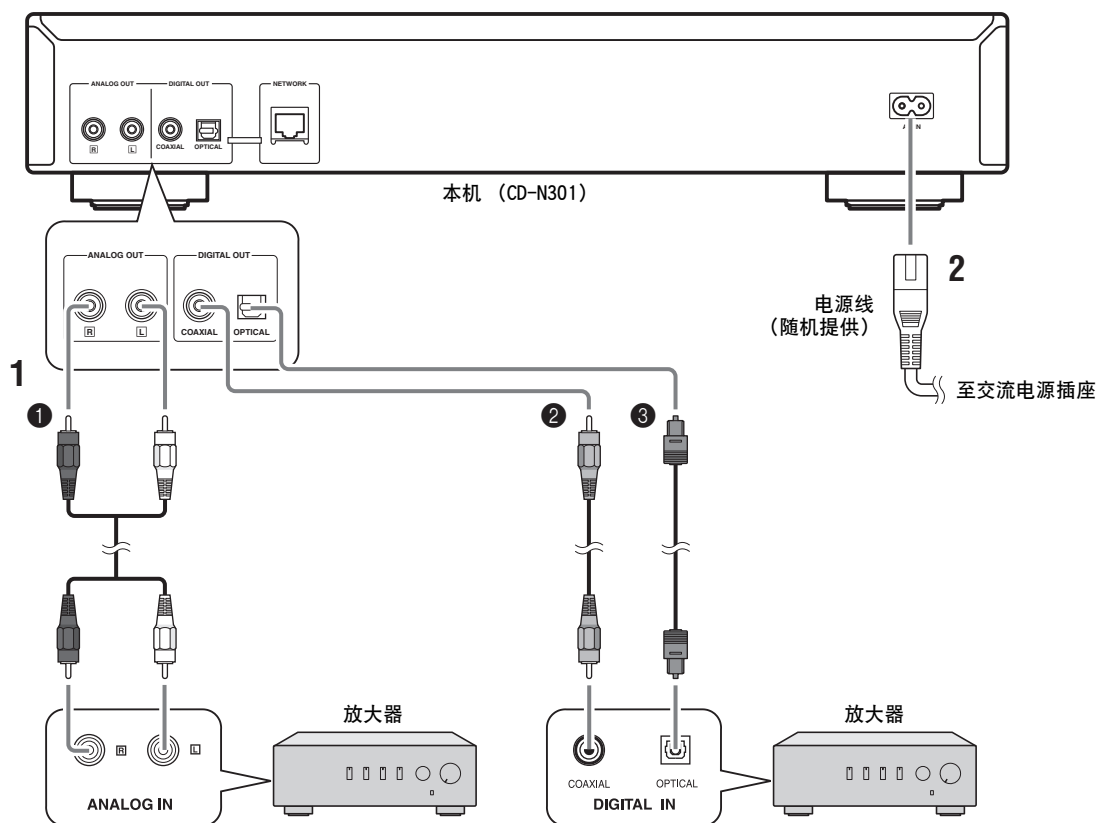

*当本机处于 PURE DIRECT 模式时，数字输出关闭。

1 用下列其中一种电缆将本机连接到放大器。

- ① RCA 立体声电缆 (随机附赠)
- ② 同轴数字音频电缆 (市售)
- ③ 光纤数字电缆 (市售)

2 将随机提供的电源线连接到 AC IN 插口，然后将插头插入交流电源插座。



有关扬声器连接的详情，请参阅您的放大器或扬声器的手册。

注意

使用数字连接时，视音频系统 (放大器) 而定，在音轨的开头音频输出可能会中断。

连接至网络 (PC/NAS/Internet 连接)

通过将本机连接到网络，可以播放 PC 或 NAS 上存储的音乐文件，及互联网电台的音频内容。用市售的 STP（屏蔽双绞线）网线（CAT-5 或更高的直通线）连接。

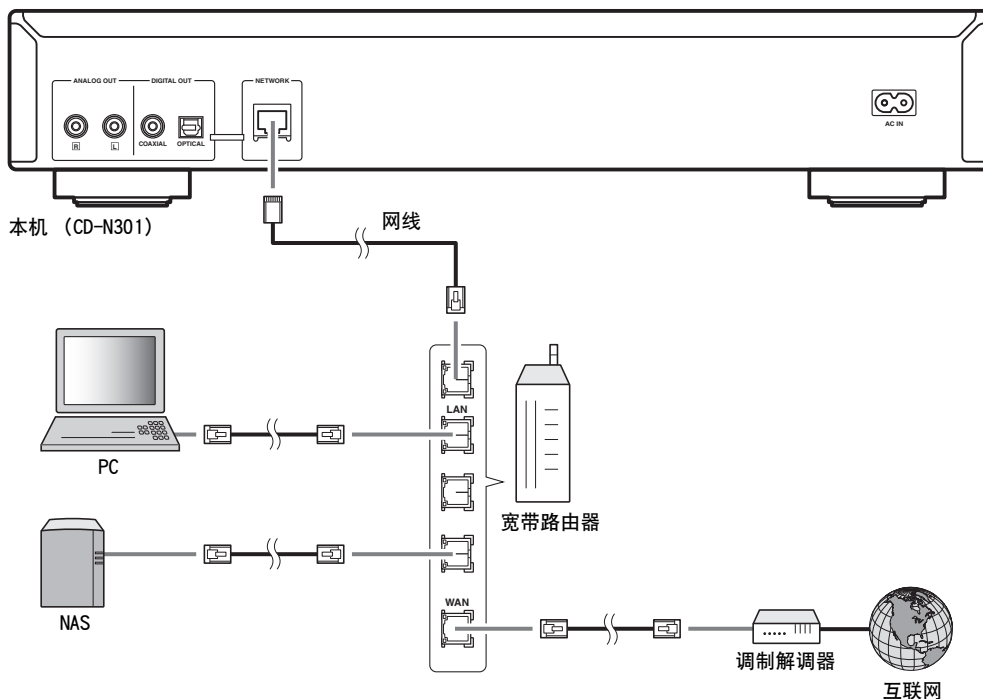

注意

- 有关网络连接的详情，请参阅网络装置的使用说明书。
- 如果您使用的路由器支持 DHCP，则不需要为本机配置任何网络设置。如果您使用的路由器不支持 DHCP，请在设置菜单的“Network Config”中配置网络设置（☞ 第 22 页）。
- 为确保出色的音质，建议对除手机之外的装置使用有线连接。
- PC 上安装的某些安全软件或网络装置（如路由器）的防火墙设置可能会阻止本机访问网络装置或互联网。这时，需要更改安全软件或网络装置的设置。
- 在手动设定子网时，必须将每台服务器连接至本机所在的子网（☞ 第 22 页）。

打开本机

当您已建立所有电缆连接后，打开本机和其他系统组件。

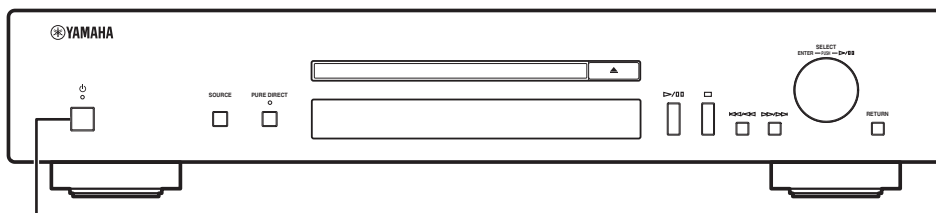

按电源开关打开本机。

打开电源开关时，通过按遥控器上的电源按钮，您可以将本机切换为打开或待机模式。启用网络待机模式时，您也可以通过网络设备控制电源等。

■ 待机 / 网络待机可操作功能

	弹出 CD	AirPlay	通过应用程序接通电源
待机	可操作	—	—
网络待机	可操作	可操作	可操作

若要启用网络待机功能，请从设置菜单中将“System Config”→“Network Standby”设置为“On”（☞ 第 22 页）。



如果特定时长后未指定任何操作，本机将自动切换至待机模式（自动待机）。您可以从设置菜单中在“System Config”→“AutoPowerStdby”中切换至待机模式（☞ 第 22 页）。

设置网络设备

配置连接至网络的装置以播放存储在设备上的音乐文件，或配置移动装置以控制本机。使用以下配置满足您的需求。



有关互联网连接的详情，请参阅您的网络设备的手册。

■ 如果您希望播放存储在 PC 上的音乐文件

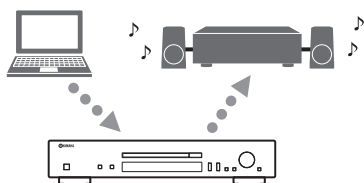

您需要配置 PC 的媒体共享设置。在 Windows Media Player 12 上配置音乐文件的媒体共享设置。有关共享设置的详情，请参阅“共享 PC 上存储的音乐文件”（第 13 页）。



您可以使用 Windows Media Player 在 PC 上操作。有关详情，请参阅 Windows Media Player 帮助。

■ 如果您希望播放存储在 NAS 上的音乐文件

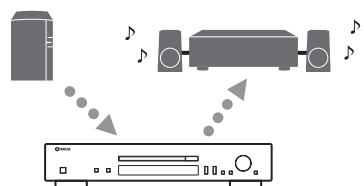

您需要配置 NAS 的媒体共享设置。设置操作因 NAS 而异。请参阅 NAS 手册。



- 如果您想手动配置网络参数，请确认您所使用的 IP 地址未用于网络中的其他网络设备。
- 在您使用 DHCP 且自动获取 IP 地址等必要网络信息的情况下。建议通常为 NAS 启用 DHCP。

■ 如果您希望通过 AirPlay 播放 iPod/iTunes

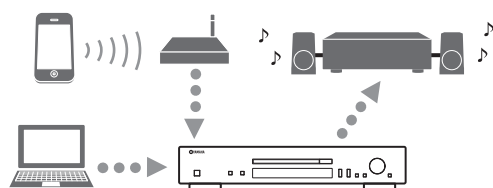

从 iPod 或从 iTunes 中选择本机（第 21 页）。请确认 iPod/iTunes 所连接的路由器与本机在相同网络中。

■ 如果您希望使用移动装置操作本机

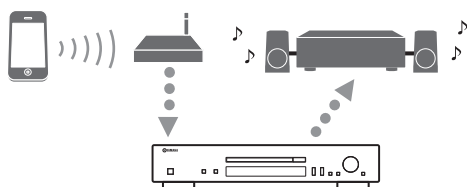

您需要下载并安装专用应用程序（第 3 页）。



- 如果您想手动配置网络参数，请确认您所使用的 IP 地址未用于网络中的其他网络设备。
- 在您使用 DHCP 且自动获取 IP 地址等必要网络信息的情况下。建议通常为移动设备启用 DHCP。

共享 PC 上存储的音乐文件

若要用本机播放电脑中存储的音乐文件，需要在本机和电脑之间进行媒体共享设置（Windows Media Player 11 或更新版本）。

有关 Windows Media Player 的详情，请参阅 Windows Media Player 帮助。



您最多可以将 16 个媒体服务器连接到本机。

■ 使用 Windows Media Player 12 时 (在 Windows 7 上)

- 1 在 PC 上启动 Windows Media Player 12。
- 2 选择“媒体流”，然后选择“打开媒体流”。



出现 PC 的控制面板窗口。

- 3 单击“启用媒体流”。

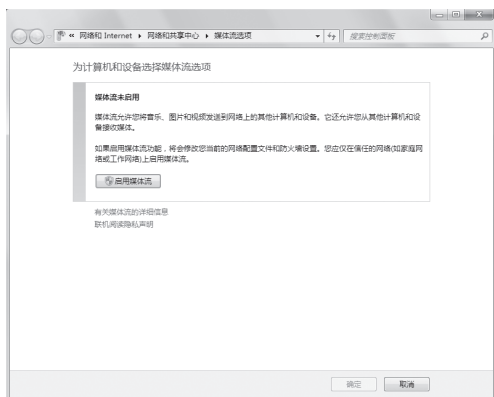

- 4 从“CD-N301”旁边的下拉菜单中选择“已允许”。

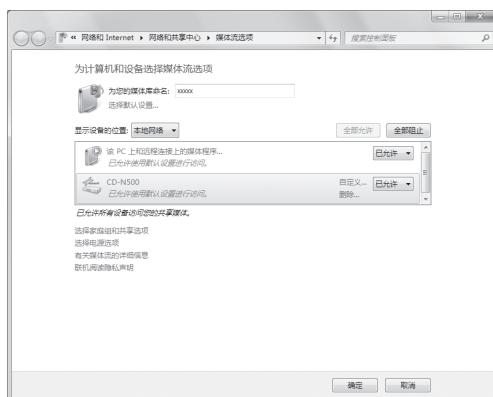

- 5 同样地，选择要用作外部媒体控制器的设备（其它 PC 或移动设备）的图标，然后单击“已允许”。

- 6 单击“确定”退出。

■ 使用 Windows Media Player 11 时

- 1 在 PC 上启动 Windows Media Player 11。
- 2 选择“媒体库”，然后选择“媒体共享”。
- 3 勾选“共享媒体的位置”复选框，选择“CD-N301”图标，然后单击“允许”。
- 4 同样地，选择要用作外部媒体控制器的设备（其它 PC 或移动设备）的图标，然后单击“允许”。
- 5 单击“确定”退出。

播放 CD

本机可以播放录有 MP3/WMA 文件的音频 CD 和数据 CD。



有关可播放 CD 的详情，请参阅“可以播放的光盘和文件格式”（第 31 页）。

前面板显示屏（示例）



图标

前面板显示屏上显示以下图标。

图标	目录
	播放 CD 时显示。
	暂停 CD 时显示。
	停止 CD 时显示。

播放 CD

1 反复按 SOURCE 将音频源切换至“CD”。

主机 / 遥控器

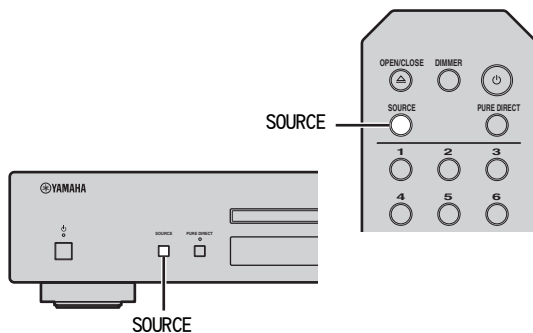

2 设置 CD

按本机上的 （打开 / 关闭）按钮，或按遥控器上的 OPEN/CLOSE 按钮打开碟片托盘，加载碟片。

3 按 （主机）或 （遥控器）开始播放。

主机 / 遥控器

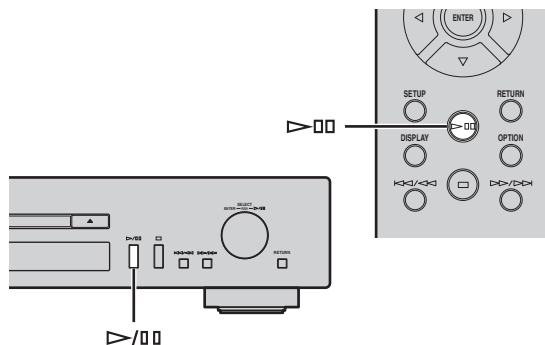

4 播放开始后，使用以下控制钮操作所需功能。

主机

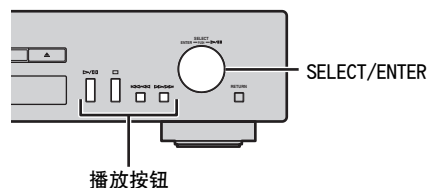

SELECT/ ENTER	翻转	跳至下一音轨，或返回至前一音轨。
	按	播放 / 暂停。
播放按钮		播放 / 暂停。
		停止播放。
		按一下跳至下一音轨，或者返回至上一音轨，或者按住向后 / 向前搜索。

遥控器

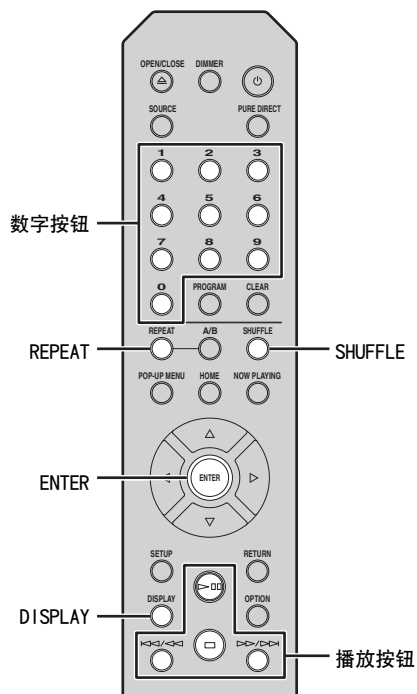

数字按钮	设置轨道编号。
ENTER	选择音乐文件时： 开始播放。
	▷□□ 播放 / 暂停。
	□ 停止播放。
播放按钮	按一下跳至下一音轨，或者返回至上一音轨，或者按住向后 / 向前搜索。
	选择重复播放方法。
REPEAT	音频 CD： REPEAT ONE / REPEAT ALL / REPEAT OFF 数据 CD： REPEAT ONE / REPEAT FOLDER / REPEAT ALL / REPEAT OFF
	选择随机播放方法。
SHUFFLE	音频 CD： SHUFFLE ALL / SHUFFLE OFF 数据 CD： SHUFFLE FOLDER / SHUFFLE ALL / SHUFFLE OFF
	更改播放信息。
DISPLAY	音频 CD (播放期间)： 播放时间 → 剩余时间 → 碟片剩余时间 → 歌曲标题* → 艺术家名称 → 专辑标题* 数据 CD (播放期间)： 播放时间 → 歌曲标题 → 艺术家名称 → 专辑标题

* 仅适合包含 CD-TEXT 的音频 CD。



- 数据 CD 上的文件按照字母数字顺序播放。
- 当 CD 播放停止时，会继续从上次播放歌曲的开头继续播放。在播放停止时按 □ 会撤销恢复播放。
- 您也可以在前面板显示屏上的指示灯上观察到重播 / 随机播放状态 (第 8 页)。

使用 A-B 重复播放

在音频 CD 播放期间，A-B 重复播放允许您为要重复的部分指定起始点和结束点。



A-B 重复播放仅适合于音频 CD。

- 1 播放音频 CD，然后在您要开始重复的点在遥控器上按 A/B 按钮。

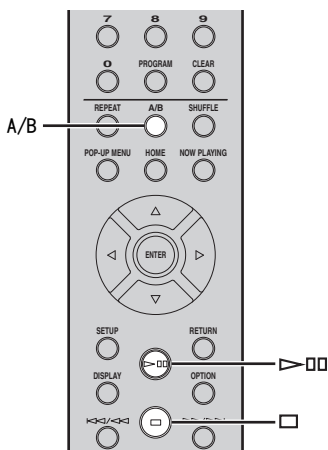

前面板显示屏（示例）



前面板上的 A-B 指示灯将在设置期间闪烁。

- 2 根据您要重复播放的结束点，在遥控器上按 A/B 按钮。

A-B 指示灯亮起，然后开始重复播放。

- 3 若要停止重复播放，停止播放或再次按 A/B 按钮。

重复播放被取消。

使用编程播放模式

在编程播放模式中，可以按编程的顺序播放音轨。



编程播放仅适合于音频 CD。

- 1 播放停止时按遥控器上的 PROGRAM。本机进入程序编辑模式。

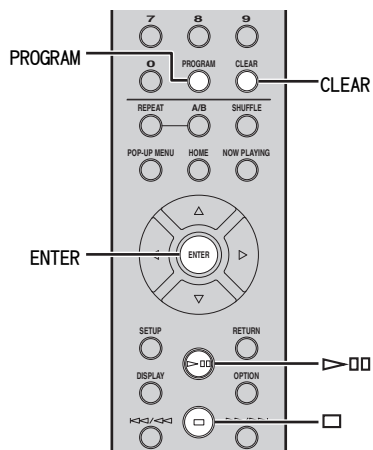

- 2 使用数字按钮选择音轨，并按 ENTER 确认。

- 3 重复步骤 2 编程下一个音轨。
最多可以编程 50 个音轨。



若要取消编程的音轨，请在程序编辑模式中按 CLEAR。最后编程的音轨将被删除。

- 4 按主机上的 ▷/⏸ (播放 / 暂停) 或遥控器上的 ▷⏸ (播放 / 暂停)。
会从编程顺序的开头开始播放。



若要删除所有编程的音轨，请在播放停止时按 CLEAR。

注意

光盘弹出或本机关闭时，编程的音轨会被删除。

播放 PC/NAS 上的音乐文件

本机可以播放连接至网络的 NAS 或计算机（服务器）中存储的音乐文件，如 MP3、WMA 或 FLAC（无损音频数据压缩格式）文件。浏览前面板显示屏并选择您喜欢的音乐文件。

若要用本机播放计算机 / NAS 中存储的音乐文件，需要在计算机 / NAS 之间进行媒体共享设置。有关共享设置的详情，请参阅“设置网络设备”（第 12 页）。



有关可播放音乐文件的详情，请参阅“可以播放的光盘和文件格式”（第 31 页）。

前面板显示屏（示例）



前面板显示屏上显示以下图标。

图标	目录
	可以选择文件夹或音乐文件时显示。
	选择文件夹时显示。
①	选择受支持的音乐文件时显示。
	播放音乐文件时显示。
	暂停音乐文件时显示。
②	当前文件夹中存在较低层级时显示。

通过主机或遥控器操作

1 反复按 SOURCE 将音频源切换至“Server”。

主机 / 遥控器

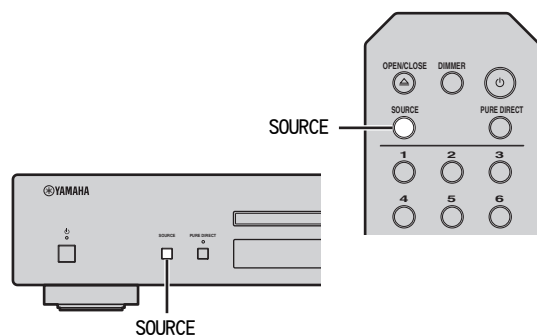

2 使用以下控制操作选择所需的音乐文件。

主机

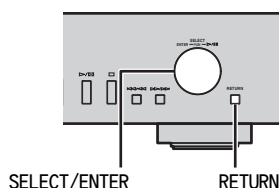

操作	说明
翻转	选择文件夹或音乐文件。
SELECT/ENTER 按	选择文件夹时： 向下移动一层级。 选择音乐文件时： 开始播放。
RETURN	返回至上一个层级。

遥控器

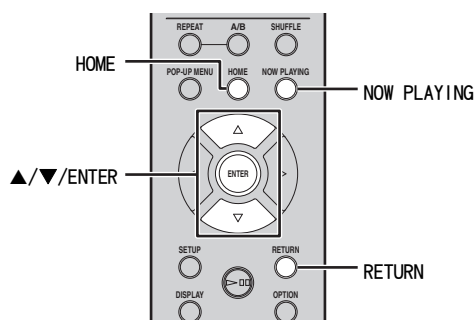

▲/▼	选择文件夹或音乐文件。
▲/▼/ENTER	选择文件夹时： 向下移动一层级。 选择音乐文件时： 开始播放。
RETURN	返回至上一个层级。
HOME	返回至顶级。
NOW PLAYING	停止浏览和显示当前所播放文件的播放信息。

3 播放开始后，使用以下控制钮操作所需功能。

主机

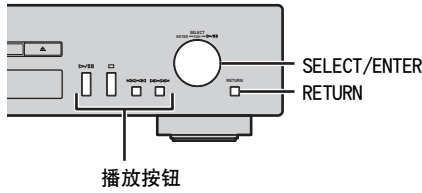

翻转	跳至文件夹中的下一首歌曲，或返回至前一歌曲。
SELECT/ENTER 按	继续播放并返回显示可选择的文件夹或音乐文件。有关选择文件夹或音乐文件的详情，请参阅步骤 2。
RETURN	继续播放并返回显示可选择的文件夹或音乐文件。有关选择文件夹或音乐文件的详情，请参阅步骤 2。
播放按钮	▷/⏸ 播放 / 暂停。
	□ 停止播放。
	◀◀/◀ 跳至文件夹中的下一首歌曲，或返回至前一歌曲。
	▶/▶▶ 跳至文件夹中的下一首歌曲，或返回至前一歌曲。

遥控器

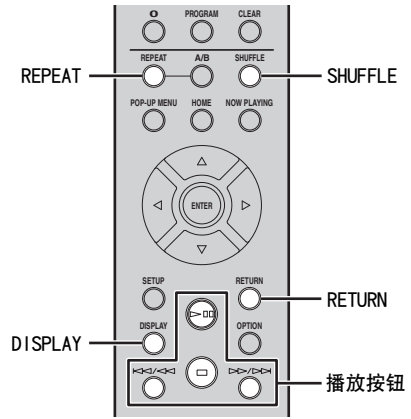

	▷/⏸ 播放 / 暂停。
播放按钮	□ 停止播放。
	◀◀/◀ 跳至文件夹中的下一首歌曲，或返回至前一歌曲。
	▶/▶▶ 跳至文件夹中的下一首歌曲，或返回至前一歌曲。
RETURN	继续播放并返回显示可选择的文件夹或音乐文件。有关选择文件夹或音乐文件的详情，请参阅步骤 2。
REPEAT	选择重复播放方法 (REPEAT ONE / REPEAT ALL / REPEAT OFF)。
SHUFFLE	选择随机播放方法 (SHUFFLE ALL / SHUFFLE OFF)。
DISPLAY	更改播放信息 (歌曲名称 → 音乐家名称 → 专辑标题 → 播放时间)。



- 您也可以在前面板显示屏上的指示灯上观察到重播 / 随机播放方式 (☞ 第 8 页)。

播放 INTERNET 电台

可通过互联网收听全世界的电台。
确保本机已正确连接至互联网（☞ 第 10 页）。

前面板显示屏（示例）

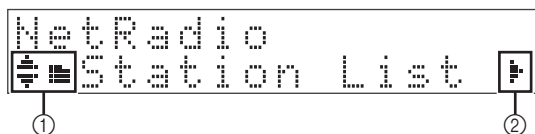

前面板显示屏上显示以下图标。

图标	目录
	可以选择文件夹或 Internet 电台时显示。
①	选择文件夹时显示。
	选择 Internet 电台时显示。
	播放 Internet 电台时显示。
②	当前文件夹中存在较低层级时显示。

1 反复按 SOURCE 将音频源切换至“Net Radio”。

主机 / 遥控器

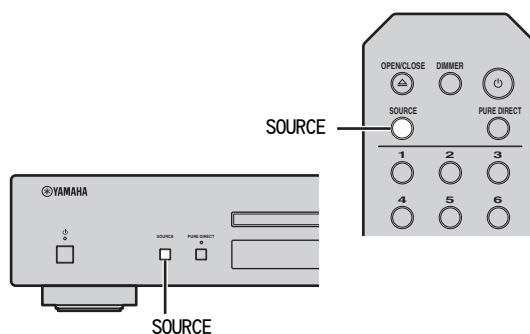

2 从文件夹中选择 Internet 电台，按 ENTER 开始播放。

☞
选择 Internet 电台时， 将显示在前面板显示屏中。

主机

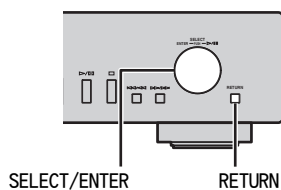

翻转	选择文件夹或 Internet 电台。
SELECT/ ENTER 按	选择文件夹时： 向下移动一级。 选择 Internet 电台时： 开始播放。
RETURN	返回至上一级。

遥控器

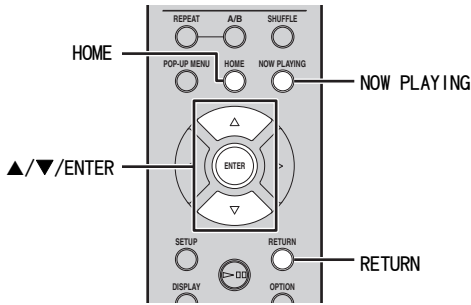

▲/▼	选择文件夹或 Internet 电台。
▲/▼/ ENTER	选择文件夹时： 向下移动一层级。 选择 Internet 电台时： 开始播放。
RETURN	返回至上一级。
HOME	返回至顶级。
NOW PLAYING	停止浏览和显示当前所播放 Internet 电台的播放信息。

3 播放开始后，使用以下控制钮操作所需功能。

主机

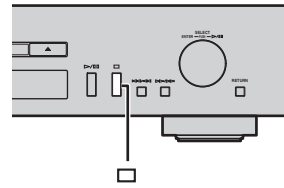

□ 停止播放。

遥控器

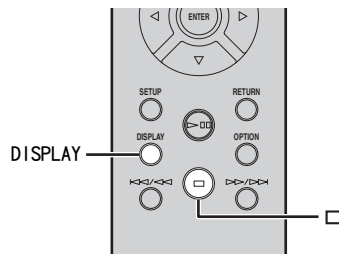

播放按钮 □ 停止播放。

DISPLAY 更改播放信息（电台名称 → 播放时间 → 歌曲标题）。

☀

可以通过选择“Net Radio”作为本机上的音频源，然后利用 PC 上的网页浏览器访问以下网站，将您喜爱的网络电台加入“Bookmarks”文件夹。
<http://yradio.vtuner.com/>
 注册 Internet 电台之前，可以使用本机播放任何 Internet 电台。
 若要使用该功能，您需要使用本机的 vTuner ID 和您的电子邮件地址创建个人帐户。您可以在“设置”菜单中的“Network Info”（第 23 页）中检查 vTuner ID（本机 MAC 地址）。

播放 AirPlay

利用 AirPlay 功能，您可通过网络在本机上无线播放 iPod/iTunes 音乐。确保将本机及 PC 或 iPod 连接至同一网络（第 10 页）。

注意

使用 iPod/iTunes 控制器来调节音量时，音量可能会意外变大。这可能会导致本机或音箱损坏。如果在播放期间音量变大，请立即停止在 iPod/iTunes 上播放。

也可使用本机和遥控器来播放、暂停、停止和跳过歌曲。

播放 iPod

- 1 打开本机，在 iPod 上显示播放画面。
如果 iPod 能够识别本机，iPod 的画面上会显示 。

对于使用 iOS 7 的 iPod，AirPlay 显示在控制中心。若要访问控制中心，在屏幕底部向上滑动手指。

iOS 6 操作示例

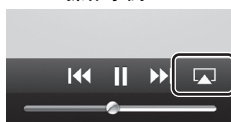

iOS 7 操作示例

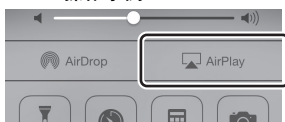

- 2 轻触 ，选择本机的名称。
源将自动切换至“AirPlay”，播放将开始。

示例



播放 iTunes

- 1 打开本机，启动 iTunes。
如果 iTunes 能够识别本机，iTunes 的画面上会显示 。

示例

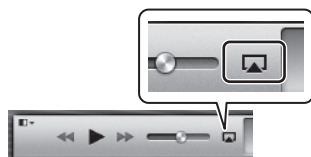

- 2 点击 ，选择本机的名称。
源将自动切换至“AirPlay”（网络待机关闭时除外）。

示例



- 3 使用 iTunes 播放歌曲。

若使用遥控器控制 iTunes 播放，需要预先将 iTunes 首选项配置为允许从远程音箱控制 iTunes。

英文本示例

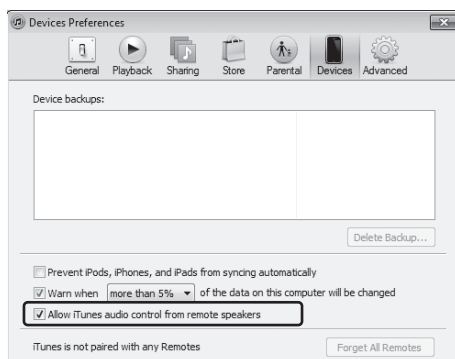

清除 AirPlay

- 1 轻触 / 点击 iPod/iTunes 画面上的  并从音箱列表中选择 CD-N301 以外的装置。或者，更改至“AirPlay”以外的音频源。

设置菜单

您可以使用设置菜单配置本机的各种设置。

设置菜单操作

■ 通过遥控器操作



有关主机或遥控器的操作详情，请查看“控制和功能”（第 5 页）。

- 1 按 **SETUP** 进入设置菜单（第 23 页）。若要使高级设置菜单项目（第 23 页）可选，请在按下 **RETURN**（主机上）的同时按 **SETUP**。

遥控器

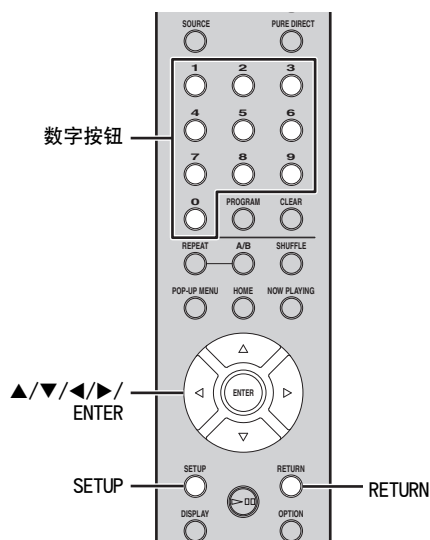

主机

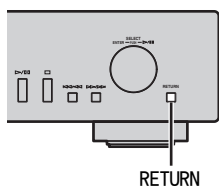

前面板显示屏

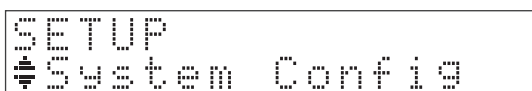

- 2 按 **▲/▼** 选择菜单项目进行配置，然后按 **ENTER**。

对某些菜单项目，可重复步骤 2 选择子菜单项目。

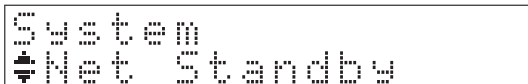

- 3 按 **◀/▶** 选择参数，然后按 **ENTER**。



- 对某些菜单项目，您需要输入数字地址。在这种情况下，按 **◀/▶** 移动目标，按 **▲/▼** 选择编号，或者使用数字按钮。然后按 **ENTER** 进行确认。
- 按 **RETURN** 按钮返回至前一个层级。

设置菜单项目

菜单	子菜单	设置 (粗体: 默认值)	功能
System Config	Net Standby	On, Off	选择“On”启用网络待机模式。
	AutoPowerStdby	20min、 2hours、 4hours、 8hours、 12hours, Off	如果本机在选定时间内保持打开而未进行播放或任何其他操作, 本机将自动进入待机模式。
	Firm Version		显示本机的固件版本。
	Firm Update		更新本机的固件 (见第 24 页)。
Network Info	Network Status		本机的网络状态显示 (“Connected” 或 “Not connected”)。
	MAC Address		显示本机 MAC 地址。MAC 地址也用作 vTuner ID。
	System ID		显示系统 ID 编号。
	Network Name		显示出现在网络上的本机名称。
Network Config	DHCP	On , Off	选择“On”使用 DHCP 服务器自动配置本机的网络设置, 或选择“Off”进行手动配置。
	IP Address		“DHCP”设置为“Off”时, 指定 IP 地址。*1
	Subnet Mask		“DHCP”设置为“Off”时, 指定子网掩码。*1
	Def. 网关		“DHCP”设置为“Off”时, 指定默认网关。*1
	DNS Server (P)		“DHCP”设置为“Off”时, 指定主 DNS 服务器。*1
	DNS Server (S)		“DHCP”设置为“Off”时, 指定二级 DNS 服务器。*1

*1:当“DHCP”为“On”时, 您可以检查 DHCP 服务器分配的值 (IP 地址等)。

高级设置菜单

仅当您按住 RETURN (主机上) 的同时按 SETUP (遥控器上) 进入设置菜单后, 以下菜单项目才可用。

菜单	设置 (粗体: 默认值)	功能
MAC Filter	On, Off	选择“On”指定允许访问本机的网络设备的 MAC 地址 (最多 5 个) (“Address1”至“Address5”)。选择“Off”可禁用 MAC 地址过滤功能。
Initialize		将本机所有设置重置为工厂默认设置。若要重置设置, 按前面板上的 SELECT/ENTER 或遥控器上的 ENTER。重置操作的结果将在下次开机时反映出来。

更新固件

发布了新固件后，前面板显示屏上将显示更新现有固件的信息（仅适用于本机连接至互联网时）。

1 按 SETUP。

前面板显示屏上显示选项菜单。

遥控器

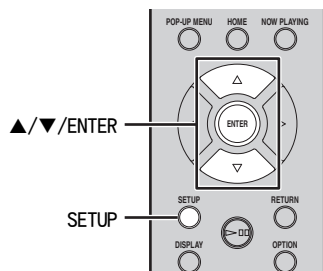

2 通过 ▲/▼ 选择 “System Config” 并按 ENTER。

3 通过 ▲/▼ 选择 “Firm Update” 并按 ENTER。

4 再次按 ENTER。

更新开始。

```
Network
S2:Writing 56%
```

当更新完成后，依次显示以下信息：“Update success”、“Please…”和“power off!”。

5 从壁上插座拔出电源线，并在约 30 秒后重新插上。

更新已应用。

注意

在固件更新期间，请不要操作本机或断开电源线或网线。

注意

- 一旦前面板显示屏上出现提示更新的信息后，即使您不执行更新，也不会再次出现。但是，在电源线从壁上插座断开一段时间之后，再打开本机时，将出现该信息。
- 当网速不够快或本机通过无线网络适配器连接到无线网络时，则可能无法进行网络更新，具体取决于无线连接的情况。在这种情况下，再次尝试。

常见问题

我需要进行哪些设置？

- 有关设置 PC、NAS 或移动设备的详情，请参阅“设置网络设备”（第 12 页）。
- 有关本机上设置菜单的详情，请参阅“设置菜单”（第 22 页）。

我在 PC 上为什么找不到音乐文件？

- 检查 PC 或媒体服务器上媒体共享设置，例如 Windows Media Player 12（第 12 页）。
- 检查音乐文件是否可播放（第 31 页）。

我是否可以用 iPhone 控制本机？

- 有关从移动设备控制本机的详情，请参阅“在移动设备上操作”（第 3 页）。

我使用移动设备上安装的专用应用程序找不到本机！

- 检查本机是否通过宽带路由器正确连接到相同网络。
- 检查对本机的访问受到 MAC 地址过滤功能的限制（第 27 页）。

本机可以播放哪些音乐文件？

- 有关可播放文件和格式的详情，请参阅“可以播放的光盘和文件格式”（第 31 页）。

我如何在本机上收听互联网广播？

- 有关聆听 Internet 电台的详情，请参阅“播放 INTERNET 电台”（第 19 页）。

我如何使用 AirPlay 播放 iPod/iTunes？

- 有关播放详情，请参阅“播放 AirPlay”（第 21 页）。

前面板显示屏上的信息表示什么？

- 有关前面板播放消息的详情，请参阅“前面板显示屏消息”（第 29 页）。

有关最新消息，请访问 Yamaha 网站。

故障排除

当本机无法正常工作时，请参阅下表。如果您所遇到的问题未在下表列出或如果以下说明没有帮助，请关闭本机，断开电源线的连接，并联系最近的 Yamaha 授权经销商或服务中心。

■ 一般参数

问题	原因	措施	页码
本机无法开机。	电源线未连接到主机上的电源输入插口或插头未插入 AC IN。	请牢固连接电源线。	9
	本机受到强烈的外部电击（例如闪电或强烈的静电）。	关闭本机，断开电源线的连接，过 30 秒之后再重新插上电源线，然后再正常使用。	—
	保护电路已被连续激活三次。当本机处于这种状态时，如果试图打开电源，主机上的电源指示灯会闪烁。	作为安全预防措施，将禁用打开电源的功能。请联系最近的 Yamaha 经销商或服务中心报修。	—
前面板上的电源指示灯闪烁。	本机内部电路存在问题。	关闭本机，断开电源线的连接，然后联系最近的 Yamaha 授权经销商或服务中心。	—
本机突然关闭。	本机进入待机模式。	在设置菜单中为“Auto Power Stdby”设置的时间到达后，本机进入待机模式。	23
无声音。	本机和放大器之间的音频电缆连接不正确。	牢固连接音频电缆。如果问题仍然存在，请使用其他音频电缆。	9
	放大器的输入设置不正确。	在放大器上选择正确的输入（来自本机）。	—
	放大器与数字信号不兼容。	使用模拟信号连接。	9
听到噪音。	本机离数字或无线电频率设备过近。	使本机远离此类设备。	—
	本机和媒体服务器之间的音频电缆故障。	牢固连接音频电缆。如果问题仍然存在，请使用其他音频电缆。	—
遥控器不工作或不能正常工作。	距离或角度错误。	遥控器在最大为 6 m 的范围内起作用，且不能偏离主机前面板轴线超过 30 度。	4
	直接阳光或光线照射到了本机的遥控传感器。	调节光线角度或重新摆放大机。	—
	电池电量微弱。	用两节新电池更换。	4
遥控器上的放大器控制钮对放大器不起作用。	您的放大器不是 Yamaha 放大器。（这些按钮可能对某些 Yamaha 放大器不起作用。）	使用您的放大器的遥控器。	—

■ 网络

问题	原因	措施	页码
网络功能不起作用。	未正确获取网络参数（IP 地址）。	在路由器上启用 DHCP 服务器功能，并在本机上将选项菜单中的“DHCP”设定为“On”。如果您想手动配置网络参数，请确认您所使用的 IP 地址未用于网络中的其他网络设备。	23
本机不检测数字媒体服务器（PC）。	媒体共享设置不正确。	配置 PC 的媒体共享设置。	12
	PC 上安装的某些安全软件阻止本机访问 PC。	检查 PC 上安装的安全软件的设置。	—
	本机和 PC 未处于同一网络。	检查网络连接和宽带路由器设置，然后将本机和 PC 连接到同一网络。	10
	对本机的访问受到 MAC 地址过滤功能的限制。	在本机的设置菜单中禁用 MAC 地址过滤功能。	23
	使用了两个以上的路由器，在网络设备上有重叠。	暂时断开互联网连接并通过本地网络检查，或将所需使用的网络设备连接到同一个路由器。	—
无法查看或播放 PC 中的文件。	本机或媒体服务器不支持此文件。	使用本机和媒体服务器支持的文件格式。有关本机所支持文件格式的详情，请参阅“可以播放的光盘和文件格式”。	31
本机无法播放某些音频文件。	您正在尝试播放从 iTunes Store 上购买的 DRM 音频文件。	您不能播放从 iTunes Store 上购买的 DRM 音频文件。	31

■ 网络电台

问题	原因	措施	页码
无法播放网络电台。	选择的网络电台当前不可用。	电台可能存在网络问题，或者服务可能已停止。请稍后再尝试收听该电台，或选择其他电台。	—
	选择的网络电台当前没有广播声音。	某些网络电台在每天的特定时段没有广播声音。请稍后再尝试收听该电台，或选择其他电台。	—
	对网络的访问受到网络设备（如宽带路由器）防火墙设置的限制。	请检查网络装置的防火墙设置。网络电台只有在通过每个广播电台指定的端口之后才能播放。端口号因电台而异。	—

■ CD

问题	原因	措施	页码
光盘托盘不能完全关闭。	异物阻挡了托盘。	仔细检查光盘托盘并取出异物。	—
不能开始光盘播放。	光盘已损坏。	仔细检查光盘，并在必要时更换。	—
	激光拾音器上有水气。	打开本机后，在尝试播放光盘前等待 20 至 30 分钟。	—
	上下颠倒放入了光盘。	将标签面朝上重新放入光盘。	—
	光盘变脏。	清洁光盘。	31
	MP3 或 WMA 文件的格式与本机不兼容。	更换为可以使用本机播放的正确录制的光盘。	31
不能开始光盘播放。	CD-RW（可重写）光盘未正确录制。	更换为可以使用本机播放的正确录制的光盘。	31
	光盘为非标准光盘，不能使用本机播放。	更换为可以使用本机播放的正确录制的光盘。	31
播放延迟，或在错误的位置开始。	光盘被划伤或损坏。	仔细检查光盘，并在必要时更换。	31
从光盘托盘内部发出噪音。	光盘弯折。	更换光盘。	—

前面板显示屏消息

信息	状态
Access error	从网络到本机的信号路径有问题。
Connected	连接至网络。
Initializing	初始化网络设置。
List updated	媒体服务器的内容列表已更新。
LOADING	正在加载指定的内容。
No content	本机找不到任何内容。
NO DISC	CD 未插入光盘托盘。
Not available	所执行的操作不可用。
Not Connected	无法连接至网络。
OPEN	CD 托盘已打开。
Program Clear	编程的轨道设定被清除。
Searching...	本机正在搜索内容。
Unknown DISC	插入了不受支持的碟片。
Unsupported	无法播放指定内容。

附加信息

本节概述 DLNA（Digital Living Network Alliance）和 NAS（网络连接存储）。

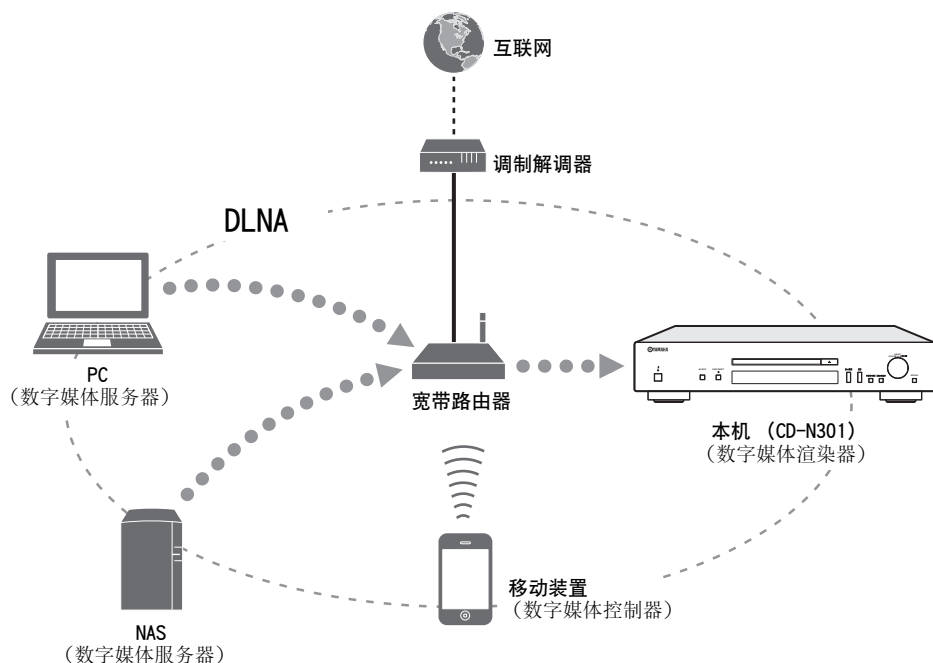

■ DLNA

“DLNA”是 Digital Living Network Alliance（数字生活网络联盟）的缩写，并作为促进家庭网络设备（如数字消费电子产品）的互联应用标准化的指南。

DLNA 装置分为四种设备类别：数字媒体服务器（DMS）、数字媒体渲染器（DMR）、数字媒体播放器（DMP）和数字媒体控制器（DMC）。

“数字媒体服务器（DMS）”是用于存储或分发数字内容（如音乐文件）的设备。对于使用本机的系统，PC 和 NAS 被视为“数字媒体服务器（DMS）”。

“数字媒体控制器（DMC）”是控制数字内容的设备。对于使用本机的系统，专用移动设备应用程序即“数字媒体控制器（DMC）”。

“数字媒体渲染器（DMR）”是接收来自“数字媒体控制器（DMC）”的指令并播放数字内容的设备，譬如本机。

类似地，“数字媒体播放器（DMP）”是可以播放“数字媒体服务器（DMS）”上存储的数字内容的设备。

■ NAS

“NAS”代表了 Network Attached Storage（网络附加存储）。通过用网线直接连接 NAS 和家庭网络，NAS 可作为硬盘驱动器等存储设备。如果您的 NAS 与 DLNA 兼容，您可以在和数字媒体服务相同的家庭网络上共享音乐、照片或电影。

可以播放的光盘和文件格式

可以播放的媒体和设备

■ 支持的 PC

安装了 Windows Media Player 11 或 Windows Media Player 12 的 PC。

■ 支持的 NAS

兼容 DLNA 版本 1.5 的 DLNA。

■ 支持的移动设备

有关详情，请访问 Yamaha 网站。

■ 可以播放的光盘

使用带有下列标记的光盘。

标记	详细说明
	光盘（数字音频）
	CD-R、CD-RW 数字音频光盘
	CD-R、CD-RW 碟片拥有以下语句之一。 FOR CONSUMER FOR CONSUMER USE FOR MUSIC USE ONLY
	• 仅最终化的 CD-R 或 CD-RW 光盘。
	注意 本机可能无法播放某些 CD-R/CD-RW 光盘或未正确录制的光盘。
	CD-TEXT 光盘 播放带有 CD TEXT 的 CD 时，除时间显示外，还会显示光盘标题、艺术家名和音轨名称。

若要播放 8-cm CD

将其放入光盘托盘的内凹区域。请勿将标准 12-cm CD 放在 8-cm CD 的上面。

注意

- 请勿使用任何市售的非标准形状光盘（心形等），否则可能会损坏本机。
- 请勿使用带有胶带、不干胶标签的光盘，或在光盘上粘贴这些物品。如果使用这样的光盘，光盘可能会卡在本机中，或者会导致本机损坏。

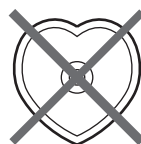

■ 关于操作光盘

- 务必小心操作，避免划伤播放表面。请勿弯折光盘。



- 为保持播放表面的清洁，使用干净的干布进行擦拭。请勿使用任何类型的光盘清洁剂、喷雾剂或任何其他化学药剂。
- 请勿绕圈擦拭光盘面；应从中心直接向外擦拭。

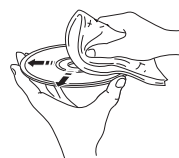

- 在光盘的标签面上书写时，请使用软头笔。
- 当光盘不在使用时，从本机中取出光盘并存放在合适的壳套中。
- 请勿将光盘长时间放置在受到阳光直射、高温或高湿的地方。

注意

请勿使用任何激光头清洁剂，否则可能会造成故障。

可以播放的光盘和文件格式

■ DLNA

格式	采样频率 (kHz)	量化比特
WAV*1	8 至 192	16/24
MP3*2	8 至 48	16
WMA*3	8 至 48	16
AAC	8 至 48	16
FLAC	8 至 192	16/24

*1 只可以播放线性 PCM 格式文件。

*2 不支持 MP3 PRO 文件。

*3 不支持 WMA PRO 和无损文件。

■ 光盘

格式	采样频率 (kHz)	量化比特
MP3	8 至 48	16
WMA	16 至 48	16

注意

- MP3 或 WMA 文件以字母数字顺序开始播放。
- 本机无法播放受版权保护的 WMA (DRM) 文件。
- 光盘必须兼容 ISO 9660。
- 播放可变比特率内容时，可能不会正确显示经过的时间。

规格

输入 / 输出

- 网络
 - 以太网连接 10Base-T/100Base-TX
 - 网络电台 支持 vTuner 服务
 - PC 客户端功能 DLNA Ver. 1.5 (DMR 功能)
 - AirPlay 支持 AirPlay
- ANALOG OUT 2ch (L/R)
- DIGITAL OUT
 - 光纤 × 1
 - 同轴 × 1

音频部分

- 输出电平
 - 1 kHz, 0 dB, fs 44.1 kHz 2.0 ± 0.3 V
- 信噪比 (IHF-A 网络)
 - 1 kHz, 0 dB, fs 44.1 kHz 110 dB 或以上
- 动态范围
 - 1 kHz, 0 dB, fs 44.1 kHz 100 dB 或以上
- 谐波失真
 - 1 kHz, 0 dB, fs 44.1 kHz 0.003% 或以下
- 频率响应
 - CD 2 Hz 至 20 kHz, -3 dB 网络
 - fs 48 kHz 2 Hz 至 24 kHz, -3 dB
 - fs 96 kHz 2 Hz 至 48 kHz, -3 dB
 - fs 192 kHz 2 Hz 至 96 kHz, -3 dB

一般参数

- 电源 AC 220 V, 50 Hz
- 功耗
 - [中国型号] 10 W
 - [韩国型号] 6 W
- 待机功耗
 - 网络待机开启 2.5 W
 - 网络待机关闭 0.4 W
- 尺寸 (宽 × 高 × 深) 435 × 86 × 260 mm
- 重量 3.2 kg

* 规格若有改变, 恕不另行通知。



AirPlay 可与 iPhone、iPad 和 iPod touch (iOS 4.3.3 或更新版本), Mac (OS X Mountain Lion) 以及 Mac 和 PC (iTunes 10.2.2 或更新版本) 一起使用。

AirPlay、iPad、iPhone、iPod、iPod nano、iPod touch 和 iTunes 是 Apple Inc. 在美国和其他国家 / 地区注册的商标。

iPad Air 和 iPad mini 是 Apple Inc. 的商标。

Windows™

Windows 是 Microsoft Corporation 在美国和其他国家 / 地区的注册商标。

Internet Explorer、Windows Media Audio 和 Windows Media Player 是 Microsoft Corporation 在美国和 / 或其他国家 / 地区的注册商标或商标。

Android™

Android 和 Google Play 是 Google, Inc. 的商标。



本机支持网络连接。



DLNA™ 和 DLNA CERTIFIED™ 是 Digital Living Network Alliance 的商标或注册商标。保留所有权利。未经授权, 严禁使用。



Fraunhofer Institut Integrierte Schaltungen

MPEG Layer-3 音频编码技术已获得 Fraunhofer IIS 和 Thomson 的许可。



该标记附加在出售到中华人民共和国的电子信息技术产品上。
环形中的数字表示的是环境保护使用期限的年数。

- : 表示该有毒有害物质在该部件所有均质材料中的含量均在 SJ/T 11363-2006 标准规定的限量要求以下。
- × : 表示该有毒有害物质至少在该部件的某一均质材料中的含量超出 SJ/T 11363-2006 标准规定的限量要求。

部件名称	有毒有害物质或元素					
	铅 (Pb)	汞 (Hg)	镉 (Cd)	六价铬 (Cr (VI))	多溴联苯 (PBB)	多溴二苯醚 (PBDE)
电路板	×	○	○	○	○	○
外壳箱体	×	○	○	○	○	○
前部面板显示器	×	○	○	○	○	○

■ 有关第三方软件授权许可的信息

■ 제 3 자 소프트웨어 사용 허가에 관한 정보

This product incorporates the following third party software.

For information (copyright, etc) about each software, please read the terms and conditions stated below.

By using this product, you will be deemed to have accepted the terms and conditions.

About ASN.1 object dumping code

ASN.1 object dumping code, copyright Peter Gutmann <pgut001@cs.auckland.ac.nz>, based on ASN.1 dump program by David Kemp <dpkemp@missi.nsc.mil>, with contributions from various people including Matthew Hamrick <hamrick@rsa.com>, Bruno Couillard <bcouillard@chrysalis-its.com>, Hallvard Furusetth <h.b.furusetth@usit.uio.no>, Geoff Thorpe <geoff@raas.co.nz>, David Boyce <d.boyce@isode.com>, John Hughes <john.hughes@entegrity.com>, Life is hard, and then you die <ronald@trustpoint.com>, Hans-Olof Hermansson <hans-olof.hermansson@postnet.se>, Tor Rustad <Tor.Rustad@bbs.no>, Kjetil Barvik <kjetil.barvik@bbs.no>, James Sweeny <jsweeny@us.ibm.com>, and several other people whose names I've misplaced.

This code grew slowly over time without much design or planning, with features being tacked on as required.

It's not representative of my normal coding style.

About FLAC codec Library

Copyright © 2000,2001,2002,2003,2004,2005,2006,2007,2008,2009 Josh Coalsen
Redistribution and use in source and binary forms, with or without modification, are permitted provided that the following conditions are met:

Redistributions of source code must retain the above copyright notice, this list of conditions and the following disclaimer.

Redistributions in binary form must reproduce the above copyright notice, this list of conditions and the following disclaimer in the documentation and/or other materials provided with the distribution.

Neither the name of the Xiph.org Foundation nor the names of its contributors may be used to endorse or promote products derived from this software without specific prior written permission.

THIS SOFTWARE IS PROVIDED BY THE COPYRIGHT HOLDERS AND CONTRIBUTORS "AS IS" AND ANY EXPRESS OR IMPLIED WARRANTIES, INCLUDING, BUT NOT LIMITED TO, THE IMPLIED WARRANTIES OF MERCHANTABILITY AND FITNESS FOR A PARTICULAR PURPOSE ARE DISCLAIMED. IN NO EVENT SHALL THE FOUNDATION OR CONTRIBUTORS BE LIABLE FOR ANY DIRECT, INDIRECT, INCIDENTAL, SPECIAL, EXEMPLARY, OR CONSEQUENTIAL DAMAGES (INCLUDING, BUT NOT LIMITED TO, PROCUREMENT OF SUBSTITUTE GOODS OR SERVICES; LOSS OF USE, DATA, OR PROFITS; OR BUSINESS INTERRUPTION) HOWEVER CAUSED AND ON ANY THEORY OF LIABILITY, WHETHER IN CONTRACT, STRICT LIABILITY, OR TORT (INCLUDING NEGLIGENCE OR OTHERWISE) ARISING IN ANY WAY OUT OF THE USE OF THIS SOFTWARE, EVEN IF ADVISED OF THE POSSIBILITY OF SUCH DAMAGE.

About libexpat

Copyright © 1998, 1999, 2000 Thai Open Source Software Center Ltd and Clark Cooper

Copyright © 2001, 2002, 2003, 2004, 2005, 2006 Expat maintainers.

Permission is hereby granted, free of charge, to any person obtaining a copy of this software and associated documentation files (the "Software"), to deal in the Software without restriction, including without limitation the rights to use, copy, modify, merge, publish, distribute, sublicense, and/or sell copies of the Software, and to permit persons to whom the Software is furnished to do so, subject to the following conditions:

The above copyright notice and this permission notice shall be included in all copies or substantial portions of the Software.

THE SOFTWARE IS PROVIDED "AS IS", WITHOUT WARRANTY OF ANY KIND, EXPRESS OR IMPLIED, INCLUDING BUT NOT LIMITED TO THE WARRANTIES OF MERCHANTABILITY, FITNESS FOR A PARTICULAR PURPOSE AND NONINFRINGEMENT. IN NO EVENT SHALL THE AUTHORS OR COPYRIGHT HOLDERS BE LIABLE FOR ANY CLAIM, DAMAGES OR OTHER LIABILITY, WHETHER IN AN ACTION OF CONTRACT, TORT OR OTHERWISE, ARISING FROM, OUT OF OR IN CONNECTION WITH THE SOFTWARE OR THE USE OR OTHER DEALINGS IN THE SOFTWARE.

About The Independent JPEG Group's JPEG software

The Independent JPEG Group's JPEG software

Copyright © 1991-2010, Thomas G. Lane, Guido Vollbeding.

All Rights Reserved except as specified below.

The authors make NO WARRANTY or representation, either express or implied, with respect to this software, its quality, accuracy, merchantability, or fitness for a particular purpose. This software is provided "AS IS", and you, its user, assume the entire risk as to its quality and accuracy.

Permission is hereby granted to use, copy, modify, and distribute this software (or portions thereof) for any purpose, without fee, subject to these conditions:

- (1) If any part of the source code for this software is distributed, then this README file must be included, with this copyright and no-warranty notice unaltered; and any additions, deletions, or changes to the original files must be clearly indicated in accompanying documentation.
- (2) If only executable code is distributed, then the accompanying documentation must state that "this software is based in part on the work of the Independent JPEG Group".
- (3) Permission for use of this software is granted only if the user accepts full responsibility for any undesirable consequences; the authors accept NO LIABILITY for damages of any kind.

These conditions apply to any software derived from or based on the IJG code, not just to the unmodified library. If you use our work, you ought to acknowledge us.

Permission is NOT granted for the use of any IJG author's name or company name in advertising or publicity relating to this software or products derived from it. This software may be referred to only as "the Independent JPEG Group's software".

We specifically permit and encourage the use of this software as the basis of commercial products, provided that all warranty or liability claims are assumed by the product vendor.

About JsonCpp

Copyright © 2007-2010 Baptiste Lepilleur

Permission is hereby granted, free of charge, to any person obtaining a copy of this software and associated documentation files (the "Software"), to deal in the Software without restriction, including without limitation the rights to use, copy, modify, merge, publish, distribute, sublicense, and/or sell copies of the Software, and to permit persons to whom the Software is furnished to do so, subject to the following conditions:

The above copyright notice and this permission notice shall be included in all copies or substantial portions of the Software.

THE SOFTWARE IS PROVIDED "AS IS", WITHOUT WARRANTY OF ANY KIND, EXPRESS OR IMPLIED, INCLUDING BUT NOT LIMITED TO THE WARRANTIES OF MERCHANTABILITY, FITNESS FOR A PARTICULAR PURPOSE AND NONINFRINGEMENT. IN NO EVENT SHALL THE AUTHORS OR COPYRIGHT HOLDERS BE LIABLE FOR ANY CLAIM, DAMAGES OR OTHER LIABILITY, WHETHER IN AN ACTION OF CONTRACT, TORT OR OTHERWISE, ARISING FROM, OUT OF OR IN CONNECTION WITH THE SOFTWARE OR THE USE OR OTHER DEALINGS IN THE SOFTWARE.

About Network

Copyright © 1988 Stephen Deering.

Copyright © 1992, 1993

The Regents of the University of California. All rights reserved.

Copyright © 1985, 1986, 1993

The Regents of the University of California. All rights reserved.

Redistribution and use in source and binary forms, with or without modification, are permitted provided that the following conditions are met:

- (1) Redistributions of source code must retain the above copyright notice, this list of conditions and the following disclaimer.
- (2) Redistributions in binary form must reproduce the above copyright notice, this list of conditions and the following disclaimer in the documentation and/or other materials provided with the distribution.
- (3) All advertising materials mentioning features or use of this software must display the following acknowledgement:
This product includes software developed by the University of California, Berkeley and its contributors.
- (4) Neither the name of the University nor the names of its contributors may be used to endorse or promote products derived from this software without specific prior written permission.

THIS SOFTWARE IS PROVIDED BY THE REGENTS AND CONTRIBUTORS "AS IS" AND ANY EXPRESS OR IMPLIED WARRANTIES, INCLUDING, BUT NOT LIMITED TO, THE IMPLIED WARRANTIES OF MERCHANTABILITY AND FITNESS FOR A PARTICULAR PURPOSE ARE DISCLAIMED. IN NO EVENT SHALL THE REGENTS OR CONTRIBUTORS BE LIABLE FOR ANY DIRECT, INDIRECT, INCIDENTAL, SPECIAL, EXEMPLARY, OR CONSEQUENTIAL DAMAGES (INCLUDING, BUT NOT LIMITED TO, PROCUREMENT OF SUBSTITUTE GOODS OR SERVICES; LOSS OF USE, DATA, OR PROFITS; OR BUSINESS INTERRUPTION) HOWEVER CAUSED AND ON ANY THEORY OF LIABILITY, WHETHER IN CONTRACT, STRICT LIABILITY, OR TORT (INCLUDING NEGLIGENCE OR OTHERWISE) ARISING IN ANY WAY OUT OF THE USE OF THIS SOFTWARE, EVEN IF ADVISED OF THE POSSIBILITY OF SUCH DAMAGE.

Copyright © 1982, 1986 Regents of the University of California.

All rights reserved.

Copyright © 1982, 1986, 1988 Regents of the University of California.

All rights reserved.

Redistribution and use in source and binary forms are permitted provided that the above copyright notice and this paragraph are duplicated in all such forms and that any documentation, advertising materials, and other materials related to such distribution and use acknowledge that the software was developed by the University of California, Berkeley. The name of the University may not be used to endorse or promote products derived from this software without specific prior written permission.

THIS SOFTWARE IS PROVIDED "AS IS" AND WITHOUT ANY EXPRESS OR IMPLIED WARRANTIES, INCLUDING, WITHOUT LIMITATION, THE IMPLIED WARRANTIES OF MERCHANTABILITY AND FITNESS FOR A PARTICULAR PURPOSE.

About PNG Reference Library

libpng versions 1.2.6, August 15, 2004, through 1.4.5, December 9, 2010, are Copyright © 2004, 2006-2010 Glenn Randers-Pehrson, and are distributed according to the same disclaimer and license as libpng-1.2.5 with the following individual added to the list of Contributing Authors

Cosmin Truta

libpng versions 1.0.7, July 1, 2000, through 1.2.5 - October 3, 2002, are Copyright © 2000-2002 Glenn Randers-Pehrson, and are distributed according to the same disclaimer and license as libpng-1.0.6 with the following individuals added to the list of Contributing Authors

Simon-Pierre Cadieux

Eric S. Raymond

Gilles Vollant

and with the following additions to the disclaimer:

There is no warranty against interference with your enjoyment of the library or against infringement. There is no warranty that our efforts or the library will fulfill any of your particular purposes or needs. This library is provided with all faults, and the entire risk of satisfactory quality, performance, accuracy, and effort is with the user.

libpng versions 0.97, January 1998, through 1.0.6, March 20, 2000, are Copyright © 1998, 1999 Glenn Randers-Pehrson, and are distributed according to the same disclaimer and license as libpng-0.96, with the following individuals added to the list of Contributing Authors:

Tom Lane

Glenn Randers-Pehrson

Willem van Schaik

libpng versions 0.89, June 1996, through 0.96, May 1997, are Copyright © 1996, 1997 Andreas Dilger

Distributed according to the same disclaimer and license as libpng-0.88, with the following individuals added to the list of Contributing Authors:

John Bowler

Kevin Bracey

Sam Bushell

Magnus Holmgren

Greg Roelofs

Tom Tanner

libpng versions 0.5, May 1995, through 0.88, January 1996, are Copyright © 1995, 1996 Guy Eric Schalnat, Group 42, Inc.

For the purposes of this copyright and license, "Contributing Authors" is defined as the following set of individuals:

Andreas Dilger

Dave Martindale

Guy Eric Schalnat

Paul Schmidt

Tim Wegner

The PNG Reference Library is supplied "AS IS". The Contributing Authors and Group 42, Inc. disclaim all warranties, expressed or implied, including, without limitation, the warranties of merchantability and of fitness for any purpose. The Contributing Authors and Group 42, Inc. assume no liability for direct, indirect, incidental, special, exemplary, or consequential damages, which may result from the use of the PNG Reference Library, even if advised of the possibility of such damage.

Permission is hereby granted to use, copy, modify, and distribute this source code, or portions hereof, for any purpose, without fee, subject to the following restrictions:

- (1) The origin of this source code must not be misrepresented.
- (2) Altered versions must be plainly marked as such and must not be misrepresented as being the original source.
- (3) This Copyright notice may not be removed or altered from any source or altered source distribution.

The Contributing Authors and Group 42, Inc. specifically permit, without fee, and encourage the use of this source code as a component to supporting the PNG file format in commercial products. If you use this source code in a product, acknowledgment is not required but would be appreciated.

About RC4 Algorithm

Copyright Mocana Corp 2003-2005. All Rights Reserved.

Proprietary and Confidential Material.

About WPA Supplicant

Copyright © 2003-2008, Jouni Malinen <j@w1.fi> and contributors

All Rights Reserved.

Redistribution and use in source and binary forms, with or without modification, are permitted provided that the following conditions are met:

- (1) Redistributions of source code must retain the above copyright notice, this list of conditions and the following disclaimer.
- (2) Redistributions in binary form must reproduce the above copyright notice, this list of conditions and the following disclaimer in the documentation and/or other materials provided with the distribution.
- (3) Neither the name(s) of the above-listed copyright holder(s) nor the names of its contributors may be used to endorse or promote products derived from this software without specific prior written permission.

THIS SOFTWARE IS PROVIDED BY THE COPYRIGHT HOLDERS AND CONTRIBUTORS "AS IS" AND ANY EXPRESS OR IMPLIED WARRANTIES, INCLUDING, BUT NOT LIMITED TO, THE IMPLIED WARRANTIES OF MERCHANTABILITY AND FITNESS FOR A PARTICULAR PURPOSE ARE DISCLAIMED. IN NO EVENT SHALL THE COPYRIGHT OWNER OR CONTRIBUTORS BE LIABLE FOR ANY DIRECT, INDIRECT, INCIDENTAL, SPECIAL, EXEMPLARY, OR CONSEQUENTIAL DAMAGES (INCLUDING, BUT NOT LIMITED TO, PROCUREMENT OF SUBSTITUTE GOODS OR SERVICES; LOSS OF USE, DATA, OR PROFITS; OR BUSINESS INTERRUPTION) HOWEVER CAUSED AND ON ANY THEORY OF LIABILITY, WHETHER IN CONTRACT, STRICT LIABILITY, OR TORT (INCLUDING NEGLIGENCE OR OTHERWISE) ARISING IN ANY WAY OUT OF THE USE OF THIS SOFTWARE, EVEN IF ADVISED OF THE POSSIBILITY OF SUCH DAMAGE.

About zlib Library

Copyright notice:

© 1995-2010 Jean-loup Gailly and Mark Adler

This software is provided "as-is", without any express or implied warranty. In no event will the authors be held liable for any damages arising from the use of this software.

Permission is granted to anyone to use this software for any purpose, including commercial applications, and to alter it and redistribute it freely, subject to the following restrictions:

- (1) The origin of this software must not be misrepresented; you must not claim that you wrote the original software. If you use this software in a product, an acknowledgment in the product documentation would be appreciated but is not required.
- (2) Altered source versions must be plainly marked as such, and must not be misrepresented as being the original software.
- (3) This notice may not be removed or altered from any source distribution.

About Apple Lossless Audio Codec

Copyright © 2011 Apple Inc. All rights reserved.

Licensed under the Apache License, Version 2.0

(the "License"); you may not use this file except in compliance with the License.

You may obtain a copy of the License at

<http://www.apache.org/licenses/LICENSE-2.0>

Unless required by applicable law or agreed to in writing, software distributed under the License is distributed on an "AS IS" BASIS, WITHOUT WARRANTIES OR CONDITIONS OF ANY KIND, either express or implied.

See the License for the specific language governing permissions and limitations under the License.

Boost

<http://www.boost.org/>

Boost Software License - Version 1.0 - August 17th, 2003

Permission is hereby granted, free of charge, to any person or organization obtaining a copy of the software and accompanying documentation covered by this license (the "Software") to use, reproduce, display, distribute, execute, and transmit the Software, and to prepare derivative works of the Software, and to permit third-parties to whom the Software is furnished to do so, all subject to the following:

The copyright notices in the Software and this entire statement, including the above license grant, this restriction and the following disclaimer, must be included in all copies of the Software, in whole or in part, and all derivative works of the Software, unless such copies or derivative works are solely in the form of machine-executable object code generated by a source language processor.

THE SOFTWARE IS PROVIDED "AS IS", WITHOUT WARRANTY OF ANY KIND, EXPRESS OR IMPLIED, INCLUDING BUT NOT LIMITED TO THE WARRANTIES OF MERCHANTABILITY, FITNESS FOR A PARTICULAR PURPOSE, TITLE AND NON-INFRINGEMENT. IN NO EVENT SHALL THE COPYRIGHT HOLDERS OR ANYONE DISTRIBUTING THE SOFTWARE BE LIABLE FOR ANY DAMAGES OR OTHER LIABILITY, WHETHER IN CONTRACT, TORT OR OTHERWISE, ARISING FROM, OUT OF OR IN CONNECTION WITH THE SOFTWARE OR THE USE OR OTHER DEALINGS IN THE SOFTWARE.

Expat

<http://www.jclark.com/xml/expat.html>

Expat License. Copyright © 1998, 1999, 2000 Thai Open Source Software Center Ltd

Permission is hereby granted, free of charge, to any person obtaining a copy of this software and associated documentation files (the "Software"), to deal in the Software without restriction, including without limitation the rights to use, copy, modify, merge, publish, distribute, sublicense, and/or sell copies of the Software, and to permit persons to whom the Software is furnished to do so, subject to the following conditions:

The above copyright notice and this permission notice shall be included in all copies or substantial portions of the Software.

THE SOFTWARE IS PROVIDED "AS IS", WITHOUT WARRANTY OF ANY KIND, EXPRESS OR IMPLIED, INCLUDING BUT NOT LIMITED TO THE WARRANTIES OF MERCHANTABILITY, FITNESS FOR A PARTICULAR PURPOSE AND NONINFRINGEMENT. IN NO EVENT SHALL THE AUTHORS OR COPYRIGHT HOLDERS BE LIABLE FOR ANY CLAIM, DAMAGES OR OTHER LIABILITY, WHETHER IN AN ACTION OF CONTRACT, TORT OR OTHERWISE, ARISING FROM, OUT OF OR IN CONNECTION WITH THE SOFTWARE OR THE USE OR OTHER DEALINGS IN THE SOFTWARE.

FastDelegate

<http://www.codeproject.com/KB/cpp/FastDelegate.aspx>

THE WORK (AS DEFINED BELOW) IS PROVIDED UNDER THE TERMS OF THIS CODE PROJECT OPEN LICENSE ("LICENSE"). THE WORK IS PROTECTED BY COPYRIGHT AND/OR OTHER APPLICABLE LAW. ANY USE OF THE WORK OTHER THAN AS AUTHORIZED UNDER THIS LICENSE OR COPYRIGHT LAW IS PROHIBITED.

BY EXERCISING ANY RIGHTS TO THE WORK PROVIDED HEREIN, YOU ACCEPT AND AGREE TO BE BOUND BY THE TERMS OF THIS LICENSE. THE AUTHOR GRANTS YOU THE RIGHTS CONTAINED HEREIN IN CONSIDERATION OF YOUR ACCEPTANCE OF SUCH TERMS AND CONDITIONS. IF YOU DO NOT AGREE TO ACCEPT AND BE BOUND BY THE TERMS OF THIS LICENSE, YOU CANNOT MAKE ANY USE OF THE WORK.

1. Definitions.

- "Articles" means, collectively, all articles written by Author which describes how the Source Code and Executable Files for the Work may be used by a user.
- "Author" means the individual or entity that offers the Work under the terms of this License.
- "Derivative Work" means a work based upon the Work or upon the Work and other pre-existing works.
- "Executable Files" refer to the executables, binary files, configuration and any required data files included in the Work.
- "Publisher" means the provider of the website, magazine, CD-ROM, DVD or other medium from or by which the Work is obtained by You.
- "Source Code" refers to the collection of source code and configuration files used to create the Executable Files.
- "Standard Version" refers to such a Work if it has not been modified, or has been modified in accordance with the consent of the Author, such consent being in the full discretion of the Author.
- "Work" refers to the collection of files distributed by the Publisher, including the Source Code, Executable Files, binaries, data files, documentation, whitepapers and the Articles.
- "You" is you, an individual or entity wishing to use the Work and exercise your rights under this License.

2. Fair Use/Fair Use Rights. Nothing in this License is intended to reduce, limit, or restrict any rights arising from fair use, fair dealing, first sale or other limitations on the exclusive rights of the copyright owner under copyright law or other applicable laws.

3. License Grant. Subject to the terms and conditions of this License, the Author hereby grants You a worldwide, royalty-free, non-exclusive, perpetual (for the duration of the applicable copyright) license to exercise the rights in the Work as stated below:

- You may use the standard version of the Source Code or Executable Files in Your own applications.
- You may apply bug fixes, portability fixes and other modifications obtained from the Public Domain or from the Author. A Work modified in such a way shall still be considered the standard version and will be subject to this License.
- You may otherwise modify Your copy of this Work (excluding the Articles) in any way to create a Derivative Work, provided that You insert a prominent notice in each changed file stating how, when and where You changed that file.
- You may distribute the standard version of the Executable Files and Source Code or Derivative Work in aggregate with other (possibly commercial) programs as part of a larger (possibly commercial) software distribution.
- The Articles discussing the Work published in any form by the author may not be distributed or republished without the Author's consent. The author retains copyright to any such Articles. You may use the Executable Files and Source Code pursuant to this License but you may not repost or republish or otherwise distribute or make available the Articles, without the prior written consent of the Author.

Any subroutines or modules supplied by You and linked into the Source Code or Executable Files this Work shall not be considered part of this Work and will not be subject to the terms of this License.

4. Patent License. Subject to the terms and conditions of this License, each Author hereby grants to You a perpetual, worldwide, non-exclusive, no-charge, royalty-free, irrevocable (except as stated in this section) patent license to make, have made, use, import, and otherwise transfer the Work.

5. Restrictions. The license granted in Section 3 above is expressly made subject to and limited by the following restrictions:

- You agree not to remove any of the original copyright, patent, trademark, and attribution notices and associated disclaimers that may appear in the Source Code or Executable Files.
- You agree not to advertise or in any way imply that this Work is a product of Your own.
- The name of the Author may not be used to endorse or promote products derived from the Work without the prior written consent of the Author.

d. You agree not to sell, lease, or rent any part of the Work. This does not restrict you from including the Work or any part of the Work inside a larger software distribution that itself is being sold. The Work by itself, though, cannot be sold, leased or rented.

e. You may distribute the Executable Files and Source Code only under the terms of this License, and You must include a copy of, or the Uniform Resource Identifier for, this License with every copy of the Executable Files or Source Code. You distribute and ensure that anyone receiving such Executable Files and Source Code agrees that the terms of this License apply to such Executable Files and/or Source Code. You may not offer or impose any terms on the Work that alter or restrict the terms of this License or the recipients' exercise of the rights granted hereunder. You may not sublicense the Work. You must keep intact all notices that refer to this License and to the disclaimer of warranties. You may not distribute the Executable Files or Source Code with any technological measures that control access or use of the Work in a manner inconsistent with the terms of this License.

f. You agree not to use the Work for illegal, immoral or improper purposes, or on pages containing illegal, immoral or improper material. The Work is subject to applicable export laws. You agree to comply with all such laws and regulations that may apply to the Work after Your receipt of the Work.

6. Representations, Warranties and Disclaimer. THIS WORK IS PROVIDED "AS IS", "WHERE IS" AND "AS AVAILABLE", WITHOUT ANY EXPRESS OR IMPLIED WARRANTIES OR CONDITIONS OR GUARANTEES. YOU, THE USER, ASSUME ALL RISK IN ITS USE, INCLUDING COPYRIGHT INFRINGEMENT, PATENT INFRINGEMENT, SUITABILITY, ETC. AUTHOR EXPRESSLY DISCLAIMS ALL EXPRESS, IMPLIED OR STATUTORY WARRANTIES OR CONDITIONS, INCLUDING WITHOUT LIMITATION, WARRANTIES OR CONDITIONS OF MERCHANTABILITY, MERCHANTABILITY QUALITY OR FITNESS FOR A PARTICULAR PURPOSE, OR ANY WARRANTY OF TITLE OR NON-INFRINGEMENT, OR THAT THE WORK (OR ANY PORTION THEREOF) IS CORRECT, USEFUL, BUG-FREE OR FREE OF VIRUSES. YOU MUST PASS THIS DISCLAIMER ON WHENEVER YOU DISTRIBUTE THE WORK OR DERIVATIVE WORKS.

7. Indemnity. You agree to defend, indemnify and hold harmless the Author and the Publisher from and against any claims, suits, losses, damages, liabilities, costs, and expenses (including reasonable legal or attorneys' fees) resulting from or relating to any use of the Work by You.

8. Limitation on Liability. EXCEPT TO THE EXTENT REQUIRED BY APPLICABLE LAW, IN NO EVENT WILL THE AUTHOR OR THE PUBLISHER BE LIABLE TO YOU ON ANY LEGAL THEORY FOR ANY SPECIAL, INCIDENTAL, CONSEQUENTIAL, PUNITIVE OR EXEMPLARY DAMAGES ARISING OUT OF THIS LICENSE OR THE USE OF THE WORK OR OTHERWISE, EVEN IF THE AUTHOR OR THE PUBLISHER HAS BEEN ADVISED OF THE POSSIBILITY OF SUCH DAMAGES.

9. Termination.

a. This License and the rights granted hereunder will terminate automatically upon any breach by You of any term of this License. Individuals or entities who have received Derivative Works from You under this License, however, will not have their licenses terminated provided such individuals or entities remain in full compliance with those licenses. Sections 1, 2, 6, 7, 8, 9, 10 and 11 will survive any termination of this License.

b. If You bring a copyright, trademark, patent or any other infringement claim against any contributor over infringements You claim are made by the Work, your License from such contributor to the Work ends automatically.

c. Subject to the above terms and conditions, this License is perpetual (for the duration of the applicable copyright in the Work). Notwithstanding the above, the Author reserves the right to release the Work under different license terms or to stop distributing the Work at any time; provided, however that any such election will not serve to withdraw this License (or any other license that has been, or is required to be, granted under the terms of this License), and this License will continue in full force and effect unless terminated as stated above.

10. Publisher. The parties hereby confirm that the Publisher shall not, under any circumstances, be responsible for and shall not have any liability in respect of the subject matter of this License. The Publisher makes no warranty whatsoever in connection with the Work and shall not be liable to You or any party on any legal theory for any damages whatsoever, including without limitation any general, special, incidental or consequential damages arising in connection to this license. The Publisher reserves the right to cease making the Work available to You at any time without notice

11. Miscellaneous.

a. This License shall be governed by the laws of the location of the head office of the Author or if the Author is an individual, the laws of location of the principal place of residence of the Author.

b. If any provision of this License is invalid or unenforceable under applicable law, it shall not affect the validity or enforceability of the remainder of the terms of this License, and without further action by the parties to this License, such provision shall be reformed to the minimum extent necessary to make such provision valid and enforceable.

c. No term or provision of this License shall be deemed waived and no breach consented to unless such waiver or consent shall be in writing and signed by the party to be charged with such waiver or consent.

d. This License constitutes the entire agreement between the parties with respect to the Work licensed herein. There are no understandings, agreements or representations with respect to the Work not specified herein. The Author shall not be bound by any additional provisions that may appear in any communication from You. This License may not be modified without the mutual written agreement of the Author and You

libogg

<http://www.xiph.org/ogg/>

Copyright © 2002, Xiph.org Foundation

Redistribution and use in source and binary forms, with or without modification, are permitted provided that the following conditions are met:

- Redistributions of source code must retain the above copyright notice, this list of conditions and the following disclaimer.
- Redistributions in binary form must reproduce the above copyright notice, this list of conditions and the following disclaimer in the documentation and/or other materials provided with the distribution.
- Neither the name of the Xiph.org Foundation nor the names of its contributors may be used to endorse or promote products derived from this software without specific prior written permission.

THIS SOFTWARE IS PROVIDED BY THE COPYRIGHT HOLDERS AND CONTRIBUTORS "AS IS" AND ANY EXPRESS OR IMPLIED WARRANTIES, INCLUDING, BUT NOT LIMITED TO, THE IMPLIED WARRANTIES OF MERCHANTABILITY AND FITNESS FOR A PARTICULAR PURPOSE ARE DISCLAIMED. IN NO EVENT SHALL THE FOUNDATION OR CONTRIBUTORS BE LIABLE FOR ANY DIRECT, INDIRECT, INCIDENTAL, SPECIAL, EXEMPLARY, OR CONSEQUENTIAL DAMAGES (INCLUDING, BUT NOT LIMITED TO, PROCUREMENT OF SUBSTITUTE GOODS OR SERVICES; LOSS OF USE, DATA, OR PROFITS; OR BUSINESS INTERRUPTION) HOWEVER CAUSED AND ON ANY THEORY OF LIABILITY, WHETHER IN CONTRACT, STRICT LIABILITY, OR TORT (INCLUDING NEGLIGENCE OR OTHERWISE) ARISING IN ANY WAY OUT OF THE USE OF THIS SOFTWARE, EVEN IF ADVISED OF THE POSSIBILITY OF SUCH DAMAGE.

libvorbis

<http://www.xiph.org/vorbis/>

Copyright © 2002-2004 Xiph.org Foundation

Redistribution and use in source and binary forms, with or without modification, are permitted provided that the following conditions are met:

- Redistributions of source code must retain the above copyright notice, this list of conditions and the following disclaimer.
- Redistributions in binary form must reproduce the above copyright notice, this list of conditions and the following disclaimer in the documentation and/or other materials provided with the distribution.
- Neither the name of the Xiph.org Foundation nor the names of its contributors may be used to endorse or promote products derived from this software without specific prior written permission.

THIS SOFTWARE IS PROVIDED BY THE COPYRIGHT HOLDERS AND CONTRIBUTORS "AS IS" AND ANY EXPRESS OR IMPLIED WARRANTIES, INCLUDING, BUT NOT LIMITED TO, THE IMPLIED WARRANTIES OF MERCHANTABILITY AND FITNESS FOR A PARTICULAR PURPOSE ARE DISCLAIMED. IN NO EVENT SHALL THE FOUNDATION OR CONTRIBUTORS BE LIABLE FOR ANY DIRECT, INDIRECT, INCIDENTAL, SPECIAL, EXEMPLARY, OR CONSEQUENTIAL DAMAGES (INCLUDING, BUT NOT LIMITED TO, PROCUREMENT OF SUBSTITUTE GOODS OR SERVICES; LOSS OF USE, DATA, OR PROFITS; OR BUSINESS INTERRUPTION) HOWEVER CAUSED AND ON ANY THEORY OF LIABILITY, WHETHER IN CONTRACT, STRICT LIABILITY, OR TORT (INCLUDING NEGLIGENCE OR OTHERWISE) ARISING IN ANY WAY OUT OF THE USE OF THIS SOFTWARE, EVEN IF ADVISED OF THE POSSIBILITY OF SUCH DAMAGE.

Tremolo

<http://wss.co.uk/pinknoise/tremolo>

Copyright © 2002-2009 Xiph.org Foundation Changes Copyright © 2009-2010 Robin Watts for Pinknoise Productions Ltd

Redistribution and use in source and binary forms, with or without modification, are permitted provided that the following conditions are met:

- Redistributions of source code must retain the above copyright notice, this list of conditions and the following disclaimer.
- Redistributions in binary form must reproduce the above copyright notice, this list of conditions and the following disclaimer in the documentation and/or other materials provided with the distribution.
- Neither the name of the Xiph.org Foundation nor the names of its contributors may be used to endorse or promote products derived from this software without specific prior written permission.

THIS SOFTWARE IS PROVIDED BY THE COPYRIGHT HOLDERS AND CONTRIBUTORS "AS IS" AND ANY EXPRESS OR IMPLIED WARRANTIES, INCLUDING, BUT NOT LIMITED TO, THE IMPLIED WARRANTIES OF MERCHANTABILITY AND FITNESS FOR A PARTICULAR PURPOSE ARE DISCLAIMED. IN NO EVENT SHALL THE FOUNDATION OR CONTRIBUTORS BE LIABLE FOR ANY DIRECT, INDIRECT, INCIDENTAL, SPECIAL, EXEMPLARY, OR CONSEQUENTIAL DAMAGES (INCLUDING, BUT NOT LIMITED TO, PROCUREMENT OF SUBSTITUTE GOODS OR SERVICES; LOSS OF USE, DATA, OR PROFITS; OR BUSINESS INTERRUPTION) HOWEVER CAUSED AND ON ANY THEORY OF LIABILITY, WHETHER IN CONTRACT, STRICT LIABILITY, OR TORT (INCLUDING NEGLIGENCE OR OTHERWISE) ARISING IN ANY WAY OUT OF THE USE OF THIS SOFTWARE, EVEN IF ADVISED OF THE POSSIBILITY OF SUCH DAMAGE.

Tremor

<http://wiki.xiph.org/index.php/Tremor>

Copyright © 2002, Xiph.org Foundation

Redistribution and use in source and binary forms, with or without modification, are permitted provided that the following conditions are met:

- Redistributions of source code must retain the above copyright notice, this list of conditions and the following disclaimer.
- Redistributions in binary form must reproduce the above copyright notice, this list of conditions and the following disclaimer in the documentation and/or other materials provided with the distribution.
- Neither the name of the Xiph.org Foundation nor the names of its contributors may be used to endorse or promote products derived from this software without specific prior written permission.

THIS SOFTWARE IS PROVIDED BY THE COPYRIGHT HOLDERS AND CONTRIBUTORS "AS IS" AND ANY EXPRESS OR IMPLIED WARRANTIES, INCLUDING, BUT NOT LIMITED TO, THE IMPLIED WARRANTIES OF MERCHANTABILITY AND FITNESS FOR A PARTICULAR PURPOSE ARE DISCLAIMED. IN NO EVENT SHALL THE FOUNDATION OR CONTRIBUTORS BE LIABLE FOR ANY DIRECT, INDIRECT, INCIDENTAL, SPECIAL, EXEMPLARY, OR CONSEQUENTIAL DAMAGES (INCLUDING, BUT NOT LIMITED TO, PROCUREMENT OF SUBSTITUTE GOODS OR SERVICES; LOSS OF USE, DATA, OR PROFITS; OR BUSINESS INTERRUPTION) HOWEVER CAUSED AND ON ANY THEORY OF LIABILITY, WHETHER IN CONTRACT, STRICT LIABILITY, OR TORT (INCLUDING NEGLIGENCE OR OTHERWISE) ARISING IN ANY WAY OUT OF THE USE OF THIS SOFTWARE, EVEN IF ADVISED OF THE POSSIBILITY OF SUCH DAMAGE.

Mersenne Twister

<http://www.math.sci.hiroshima-u.ac.jp/~m-mat/MT/MT2002/CODES/mt19937ar.c>

Copyright © 1997 - 2002, Makoto Matsumoto and Takuji Nishimura,

All rights reserved.

Redistribution and use in source and binary forms, with or without modification, are permitted provided that the following conditions are met:

1. Redistributions of source code must retain the above copyright notice, this list of conditions and the following disclaimer.
2. Redistributions in binary form must reproduce the above copyright notice, this list of conditions and the following disclaimer in the documentation and/or other materials provided with the distribution.
3. The names of its contributors may not be used to endorse or promote products derived from this software without specific prior written permission.

THIS SOFTWARE IS PROVIDED BY THE COPYRIGHT HOLDERS AND CONTRIBUTORS "AS IS" AND ANY EXPRESS OR IMPLIED WARRANTIES, INCLUDING, BUT NOT LIMITED TO, THE IMPLIED WARRANTIES OF MERCHANTABILITY AND FITNESS FOR A PARTICULAR PURPOSE ARE DISCLAIMED. IN NO EVENT SHALL THE COPYRIGHT OWNER OR CONTRIBUTORS BE LIABLE FOR ANY DIRECT, INDIRECT, INCIDENTAL, SPECIAL, EXEMPLARY, OR CONSEQUENTIAL DAMAGES (INCLUDING, BUT NOT LIMITED TO, PROCUREMENT OF SUBSTITUTE GOODS OR SERVICES; LOSS OF USE, DATA, OR PROFITS; OR BUSINESS INTERRUPTION) HOWEVER CAUSED AND ON ANY THEORY OF LIABILITY, WHETHER IN CONTRACT, STRICT LIABILITY, OR TORT (INCLUDING NEGLIGENCE OR OTHERWISE) ARISING IN ANY WAY OUT OF THE USE OF THIS SOFTWARE, EVEN IF ADVISED OF THE POSSIBILITY OF SUCH DAMAGE.

zlib

<http://www.zlib.net/>

zlib.h -- interface of the 'zlib' general purpose compression library version 1.2.3, July 18th, 2005

Copyright © 1995-2004 Jean-loup Gailly and Mark Adler

This software is provided 'as-is', without any express or implied warranty. In no event will the authors be held liable for any damages arising from the use of this software.

Permission is granted to anyone to use this software for any purpose, including commercial applications, and to alter it and redistribute it freely, subject to the following restrictions:

The origin of this software must not be misrepresented; you must not claim that you wrote the original software. If you use this software in a product, an acknowledgment in the product documentation would be appreciated but is not required.

1. Altered source versions must be plainly marked as such, and must not be misrepresented as being the original software.
2. This notice may not be removed or altered from any source distribution.

Jean-loup Gailly jloup@gzip.org, Mark Adler madler@alumni.caltech.edu

cURL

<http://curl.haxx.se>

COPYRIGHT AND PERMISSION NOTICE

Copyright © 1996 - 2011, Daniel Stenberg, <daniel@haxx.se>.

All rights reserved.

Permission to use, copy, modify, and distribute this software for any purpose with or without fee is hereby granted, provided that the above copyright notice and this permission notice appear in all copies.

THE SOFTWARE IS PROVIDED "AS IS", WITHOUT WARRANTY OF ANY KIND, EXPRESS OR IMPLIED, INCLUDING BUT NOT LIMITED TO THE WARRANTIES OF MERCHANTABILITY, FITNESS FOR A PARTICULAR PURPOSE AND NONINFRINGEMENT OF THIRD PARTY RIGHTS. IN NO EVENT SHALL THE AUTHORS OR COPYRIGHT HOLDERS BE LIABLE FOR ANY CLAIM, DAMAGES OR OTHER LIABILITY, WHETHER IN AN ACTION OF CONTRACT, TORT OR OTHERWISE, ARISING FROM, OUT OF OR IN

CONNECTION WITH THE SOFTWARE OR THE USE OR OTHER DEALINGS IN THE SOFTWARE.

Except as contained in this notice, the name of a copyright holder shall not be used in advertising or otherwise to promote the sale, use or other dealings in this Software without prior written authorization of the copyright holder.

c-ares

<http://c-ares.haxx.se>

Copyright 1998 by the Massachusetts Institute of Technology.

Permission to use, copy, modify, and distribute this software and its documentation for any purpose and without fee is hereby granted, provided that the above copyright notice appear in all copies and that both that copyright notice and this permission notice appear in supporting documentation, and that the name of M.I.T. not be used in advertising or publicity pertaining to distribution of the software without specific, written prior permission. M.I.T. makes no representations about the suitability of this software for any purpose. It is provided "as is" without express or implied warranty.

Do not disassemble, decompile, or reverse engineer the software included in Yamaha AV products.

注意

使用此处指定外的控制或调节以及进行指定外的操作都有可能引起有害的辐射暴露。

주의

여기서 지정한 이외의, 조정이나 제어 또는 동작을 실시했을 경우, 유해한 방사선에 노출될 위험이 있습니다.

本机激光部件的辐射级别大于 1 级限度。

본 제품의 레이저 컴포넌트는 Class 1 의 범위를 초과하는 방사선을 방출할 가능성이 있습니다.

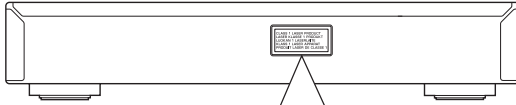

中国型号

CLASS 1 LASER PRODUCT
LASER KLASSE 1 PRODUKT
LUOKAN 1 LASERLAITE
KLASS 1 LASER APPARAT
PRODUIT LASER DE CLASSE 1
1类激光产品

한국 모델

CLASS 1 LASER PRODUCT
LASER KLASSE 1 PRODUKT
LUOKAN 1 LASERLAITE
KLASS 1 LASER APPARAT
PRODUIT LASER DE CLASSE 1

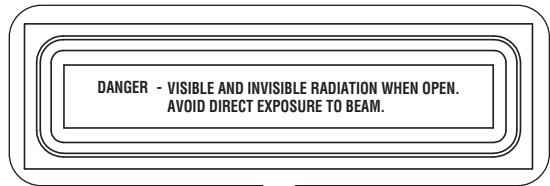

DANGER - VISIBLE AND INVISIBLE RADIATION WHEN OPEN.
AVOID DIRECT EXPOSURE TO BEAM.

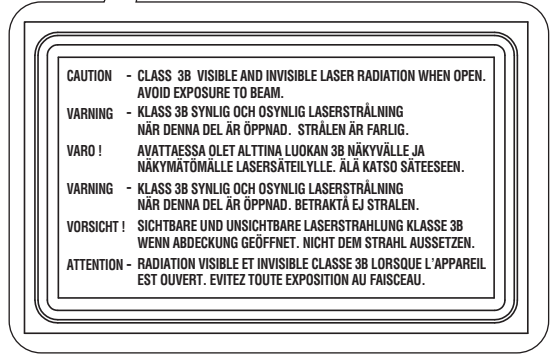
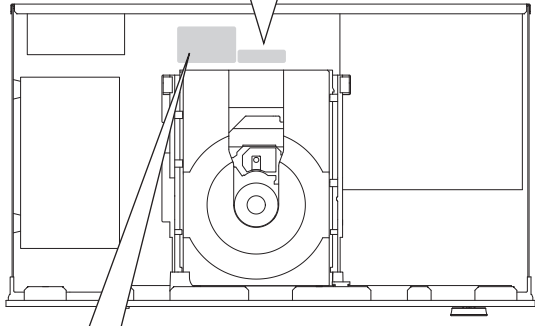

CAUTION - CLASS 3B VISIBLE AND INVISIBLE LASER RADIATION WHEN OPEN.
AVOID EXPOSURE TO BEAM.
VARNING - KLASS 3B SYNLIG OCH OSYNLIG LASERSTRÅLNING
NÄR DENNA DEL ÄR ÖPPNAD. STRÅLEN ÄR FARLIG.
VARO! AVATTAESSA OLET ALTTIIN LUOKAN 3B NÄKYVÄLLE JA
NÄKYMÄTÖMÄLLE LASERSÄTEILYLLE. ÄLÄ KATSO SÄTEESEEN.
VARNING - KLASS 3B SYNLIG OCH OSYNLIG LASERSTRÅLNING
NÄR DENNA DEL ÄR ÖPPNAD. BETRÄKTÄ EJ STRALEN.
VORSICHT! SICHTBARE UND UNSICHTBARE LASERSTRAHLUNG KLASSE 3B
WENN ABDECKUNG GEÖFFNET. NICHT DEM STRAHL AUSSETZEN.
ATTENTION - RADIATION VISIBLE ET INVISIBLE CLASSE 3B LORSQUE L'APPAREIL
EST OUVERT. EVITEZ TOUTE EXPOSITION AU FAISCEAU.

激光安全

本机使用激光。因为可能会伤害眼睛，仅可由具有资格的维修人员拆卸罩盖或试图对本装置进行维修服务。

危险

打开本机时，机器会放出可见激光射线。为了避免光束直接照射到眼睛上，在插上本机的交流电源时，不要将眼睛对着打开的托盘或者其他打开着的装置，并且不要往装置内部窥视。

激光头

类型 半导体激光GaAs/GaAlAs
波长 790 nm
输出功率 10 mW

레이저 안전

본 기기는 레이저를 사용하고 있습니다. 시력이 손상될 수 있으므로 공인 서비스 기술자만 커버를 열고 본 기기를 수리해야 합니다.

위험

본 기기를 열면 가시 레이저 방사선이 방출됩니다. 육안으로 빔을 직접 보지 마십시오. 본 기기의 플러그를 콘센트에 꽂은 경우, 디스크 슬롯 및 다른 개구부를 통해 기기 내부를 들여다 보지 마십시오.

레이저

유형 반도체 레이저 GaAs/GaAlAs
파장 790 nm
출력 10 mW

